

12.5" LAPSCREEN Touch Monitor

FT125TMLSC

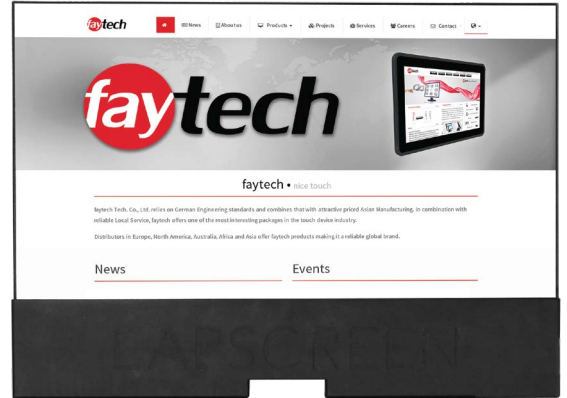

- Full HD (1920 x 1080) LCD Panels
- Perfect touch monitor for people on-the-go
- 10-Finger-Multi Touch Capacitive Touch Panel
- Optically bonded Touch Panel to LCD Panel
- Thickness of less than 4mm (screen) / 8mm (mainboard)
- A4 Format in length and US letter format in width
- Weight of around 400 grams
- Supports a wide range of OS systems
- Plug and play ready



This **lightweight portable monitor**, also known as the **LAPSCREEN**, is the perfect solution for people that require an extra screen while doing their day-to-day activities. Whether you connect it to your mobile phone, tablet or laptop, it will be an easy and convenient way of extending (or duplicating) the screen of your smart device over **USB Type-C** or **HDMI cable**.

With a weight of only **350-400 gram** and roughly similar measurements as an **A4 paper / US letter**, would this monitor work perfect for people on-the-go. There is currently a 10-point multi-touch version available, as well as a non-touch version, your solution for your needs! Whether you are on a business trip, with the need to give presentations in different locations, a student constantly working on different projects or just a casual traveller that needs an extra screen, the **LAPSCREEN** is the solution for you.

The monitor has a full HD LCD Panel with a thickness of less than 4mm and no bezel on the sides and top, it is **invented by Michél Haese** and exclusively **produced by faytech**. The **LAPSCREEN** is also referred to as the 3rd evolution of mobile computing right after the **LAPTOP** and **SMARTPHONE**, due to its innovative design and many application uses.

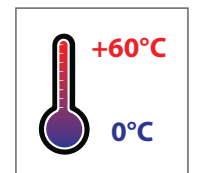
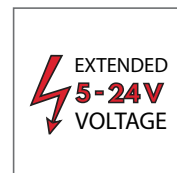
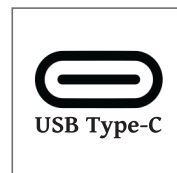
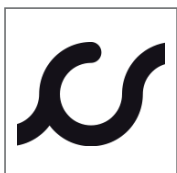

Product name	12.5" LAPSCREEN Touch Monitor
Article code / EAN number	FT125TMLSC

IP Rating	
IP40	

LCD Panel	
Screen diagonal (Inch/cm)	12.5/31.75
Display active screen size (cm)	27.60×15.60
Aspect ratio	16:9
Physical resolution	1920×1080
Maximum showable resolution	1920×1200
Colours displayed	16.7M
Brightness (cd/m²)	300
Contrast	700:1
Typical reaction time Tr/ Tf (ms)	14/11
Visual Angle horizontal/vertical (°)	178/178
Backlight / Backlight Lifetime (hours)	LED / min. 15,000

Included in the Delivery	
USB Type-C Cable	

Touch Panel	
Touch Technology	Projected Capacitive 10-point Multitouch
Touch Panel Drivers	Windows; Linux; Mac; Android
Touch Life (Contacts)	Unlimited
Surface Hardness	7H
Surface Treatment	Anti-glare (chemical etched)

Operation / Mechanical	
Operating Temperature (°C)	0 ~ +60
Humidity Range (RH)	20% - 80%
Net weight (kg)	0.40
Gross weight (kg)	1.15 (incl. cartonage)
Housing material	Black powdered aluminum
Housing (cm) L × W × H	28.52 × 21.37 × 0.79

Power	
Power Supply	5V / 12V / 20V DC-In
Working Power (V)	5-24
Power Consumption (W)	7.5
Stand-By Consumption (W)	0.5

External Connectors	
1x HDMI	
1x USB Type-C - for Video (side connector)	
1x USB Type-C - for Power (bottom connector)	

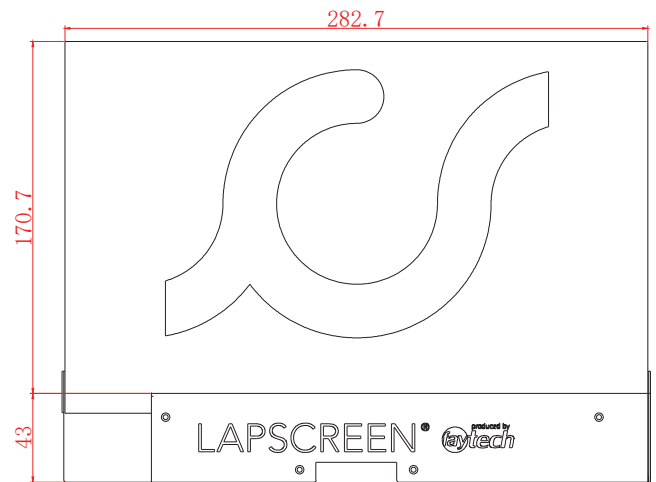
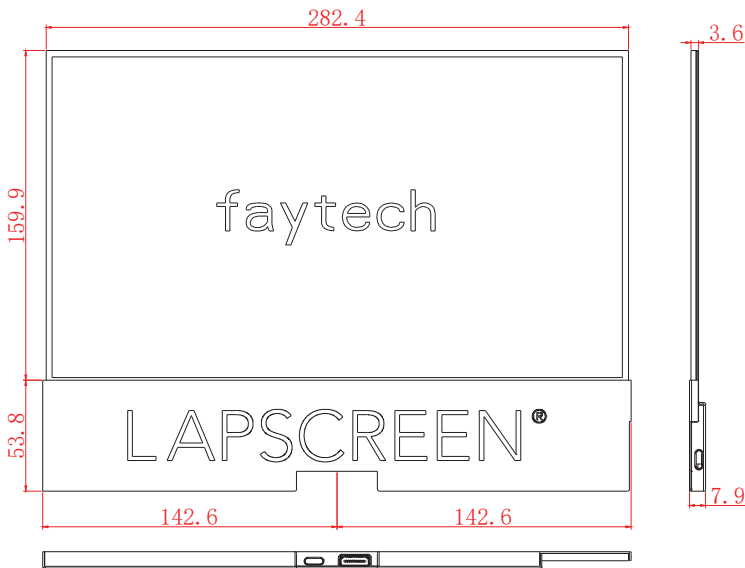

Corporate Headquarters

faytech AG
 Bischhäuser Aue 10
 37213 Witzenhausen
 Germany

support@faytech.com
contact@faytech.com
www.faytech.com

China: +86 755 8958 0612
 Germany: +49 5542 30374 10
 USA: +1 646 205 3214
 India: +91 11 49707436
 Japan: +070 4127 5167