

COUNT	DESCRIPTION OF REVISIONS	BY	CHKD	DATE	COUNT	DESCRIPTION OF REVISIONS	BY	CHKD	DATE
△				..	△				..
△				..	△				..
△				..	△				..

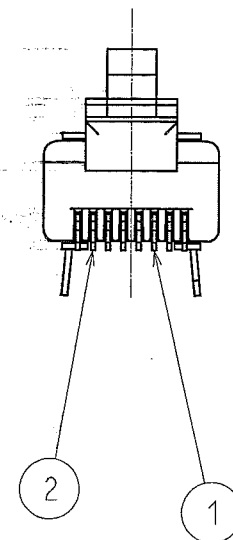

5 ATTACHED

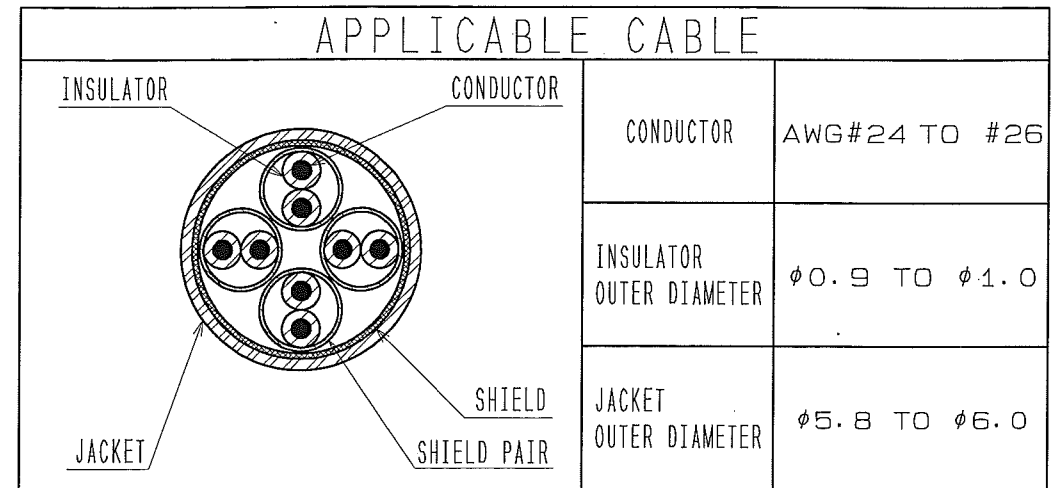
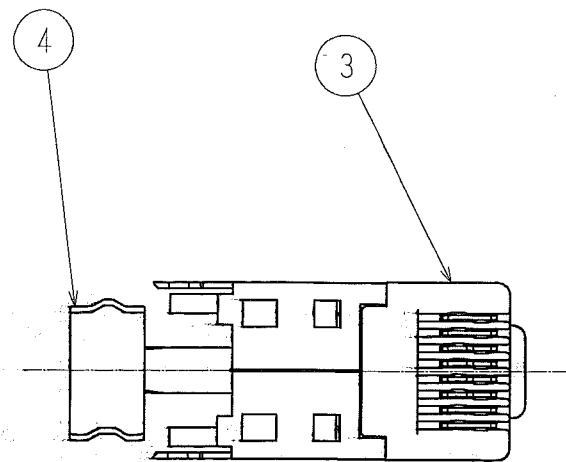
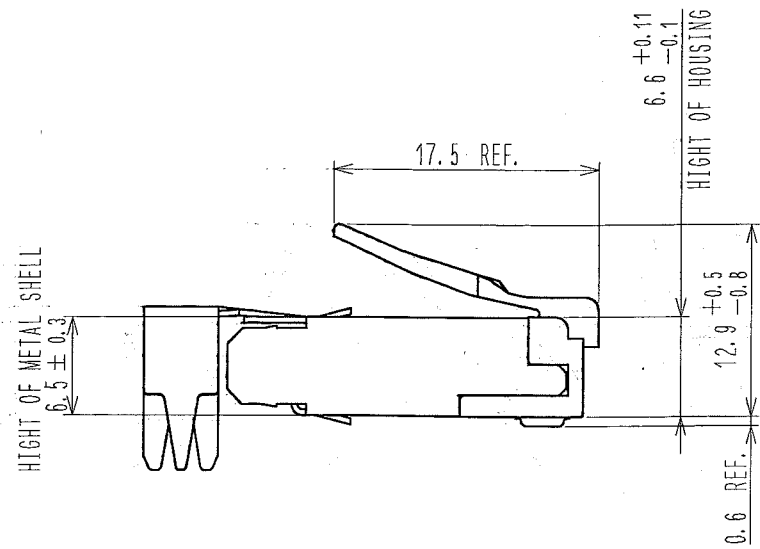
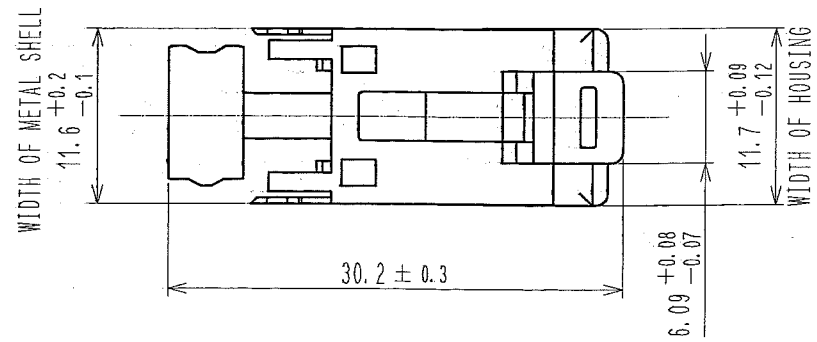
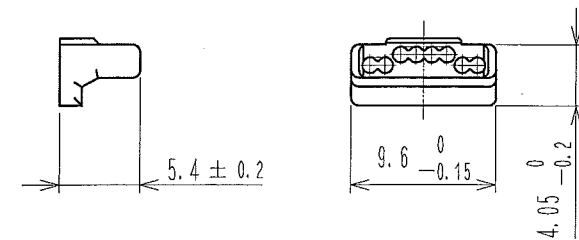

1~2	PHOSPHOR BRONZE	CONTACT: Au 1.27μm min OTHER: Au 0.03μm min UNDER: Ni 2μm min	4	POLYCARBONATE (CLEAR YELLOW)	
			3	STAINLESS STEEL Ni 0.5μm min	
			2	POLYCARBONATE (CLEAR YELLOW)	
NO.	MATERIAL	FINISH, REMARKS	NO.	MATERIAL	FINISH, REMARKS

CODE NO.(OLD)	DRAWN	DESIGNED	CHECKED	APPROVED	RELEASED
DRAWING FOR REFERENCE OR PRELIMINARIES	M. Itano '08.07.18	M. Itano '08.07.18	H. Yamada '08.07.18	Y. Enomi '08.07.18	ENG '08.7.18 DEPT
SCALE 2:1	DRAWING NO. TEDC3-123817	PART NO. TM31P-88P			
UNITS mm	HRS HIROSE ELECTRIC CO., LTD	CODE NO. CL222	1/1		

TO
Q

Plug : TM31P-TM-88P



1. Plug design satisfying CAT6a performance
(No.1,2,7,8⇒short contacts /No.3,4,5,6⇒long contacts)
2. Simplified assembly method by guide plate
3. Steady cable assembly procedure
4. AWG24-27, stranded PIMP cable is applicable
5. IDC and clamping process can be implemented by same specific tool

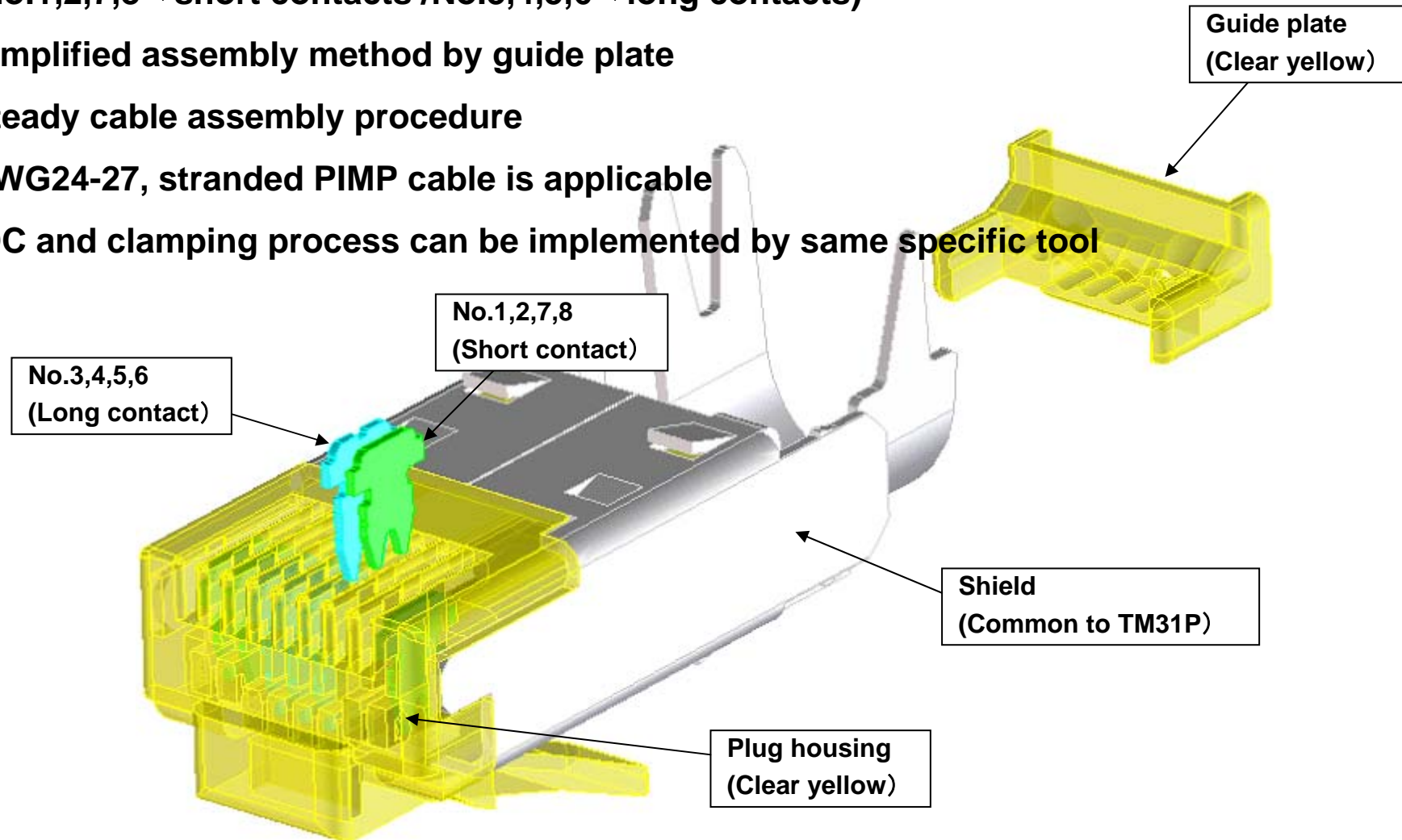

Plug : TM31P-TM-88P



Plug design satisfying CAT6a requirements

1) Unique contact arrangement

CAT6 Plug (TM21DP-TM-88P)

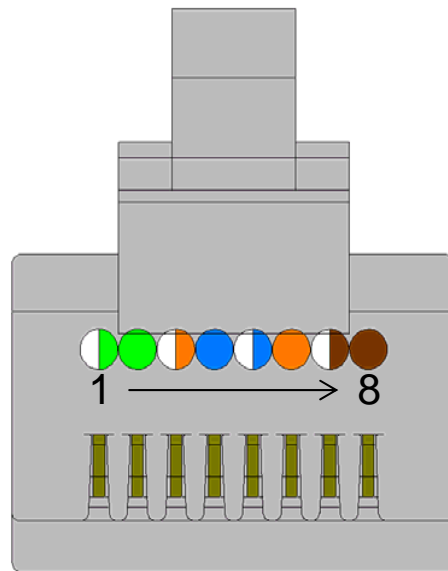

Limited performance due to the contact arrangement in a single row

CAT6a Plug (TM31P-TM-88P)

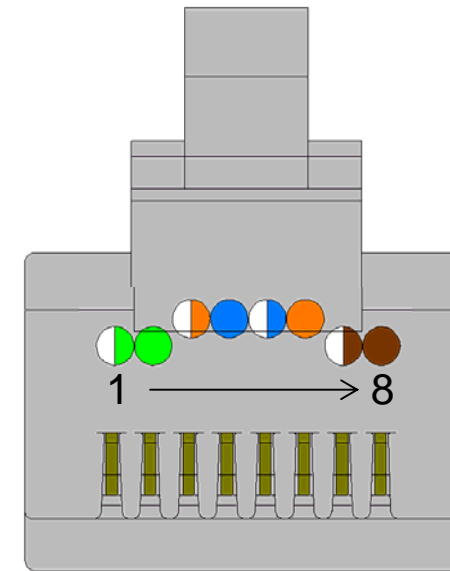
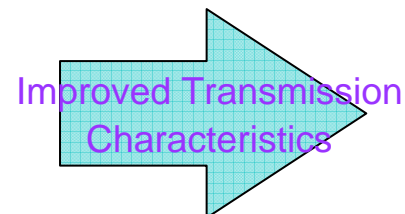

The contact arrangement in two rows makes performance improved (No3, 4, 5, 6 contacts are isolated from No1, 2, 7, 8 contacts)

Plug : TM31P-TM-88P



Cable assembly method to have CAT6a performance

Plug design makes it possible for users to lengthen jacket end and have steady CAT6a performance.

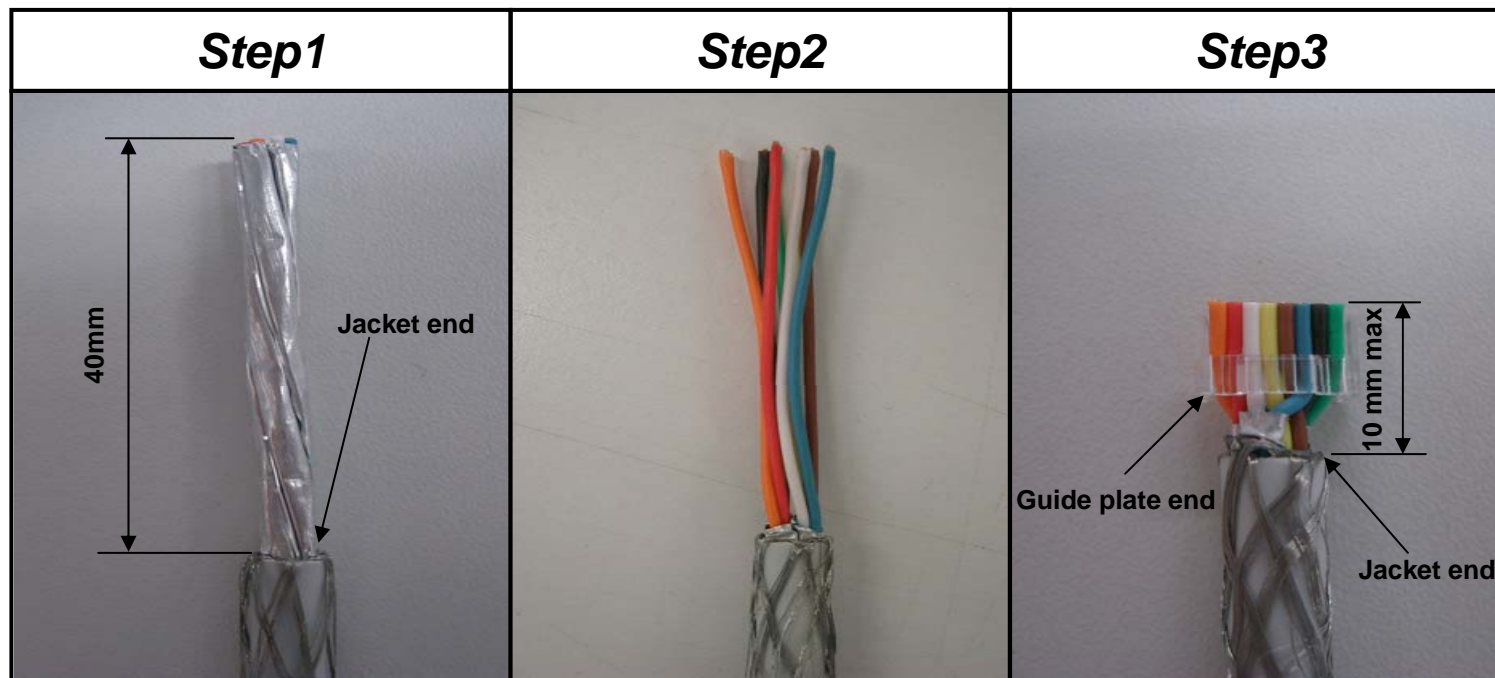

Plug : TM31P-TM-88P



Cable assembly method to have CAT6a performance

Plug design makes it possible for users to lengthen jacket end and have steady CAT6a performance.

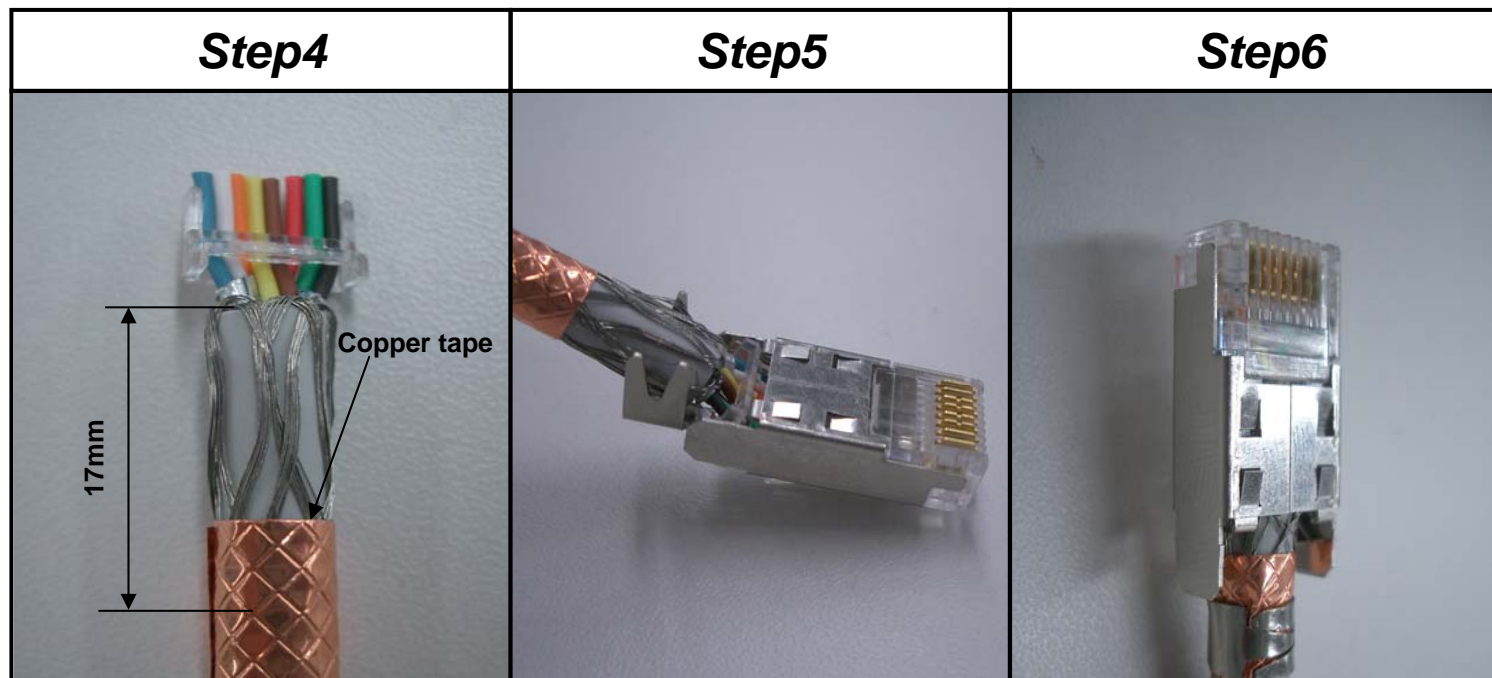

Plug : TM31P-TM-88P



Outer Appearance of TM31P-TM-88P with cover

TM31P-TM-88P can be assembled with TM21 covers.

Our CAT6A modular plug is consist of just 3 parts.

1. Plug Body (TM31P-TM-88P)
2. Guide Plate (TM31P Guide Plate)
3. Cover (TM21 Cover)

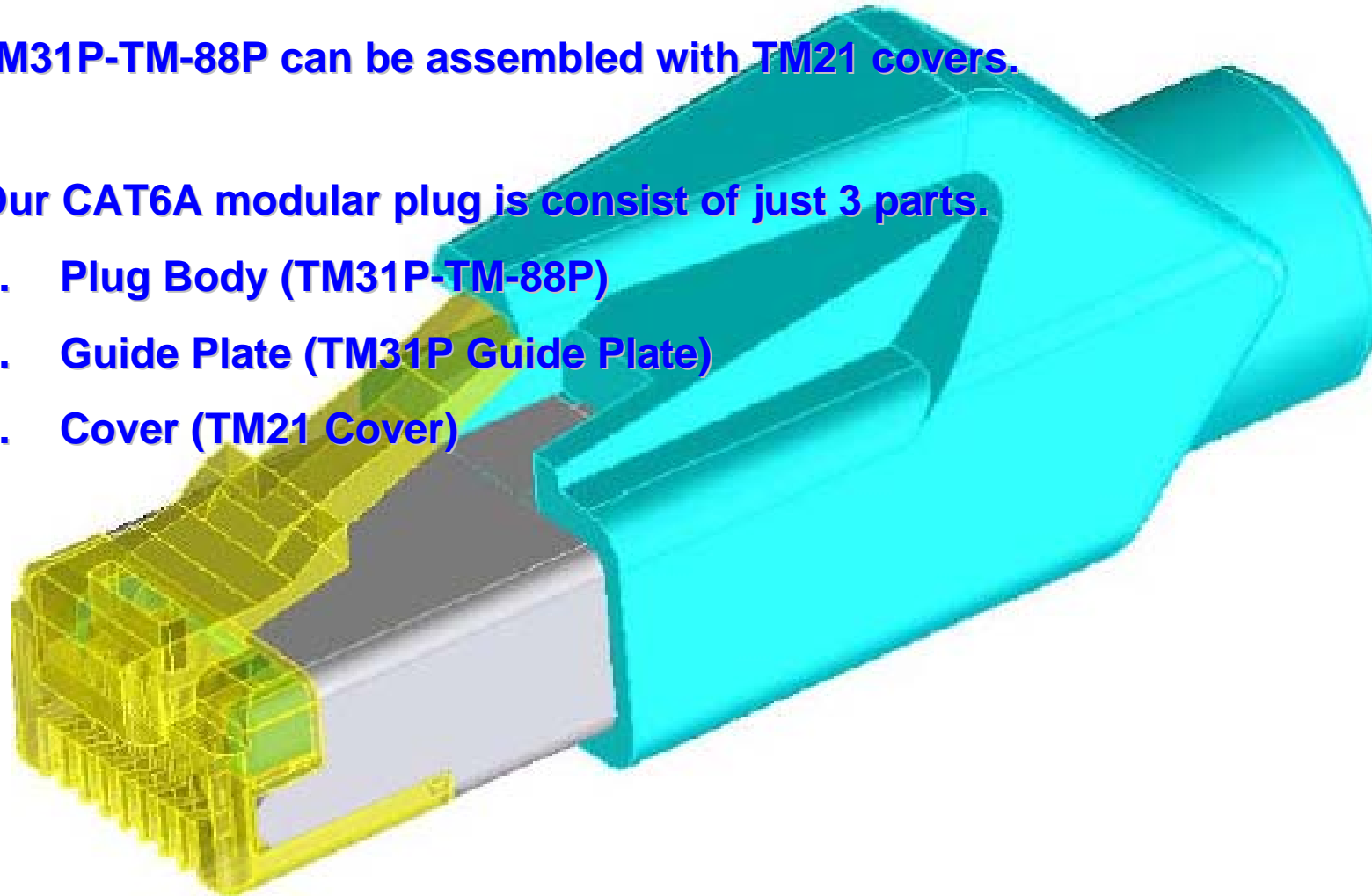

Plug : TM31P-TM-88P

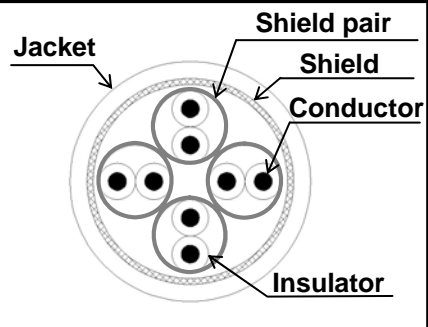

Applicable Cable

	Conductor	AWG 24 stranded wire
		AWG 27 stranded wire
	O/D of Insulator	ϕ 0.9 to ϕ 1.0
	O/D of Jacket	ϕ 5.8 to ϕ 6.0

Cable Assembly Tool

Cable Assembly Tool of TM21DP-TM-88P
can be also used for TM31P-TM-88P



Plug : TM31P-TM-88P



CAT6a Performance Measurement : Plug single TM31P Model sample

Measurement Method : Direct Probe Method
Measurement Equipment : Network Analyzer
(Agilent E8357A)

Frequency : 10~500MHz

