

# AMJ-Kupplung K Cat.6 / AMJ coupler K Cat.6

Montageausschnitt  
assembly cutout

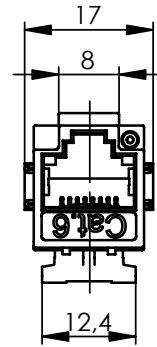

## 19"-Modulträger 1 HE / 19" frontplate 1HU

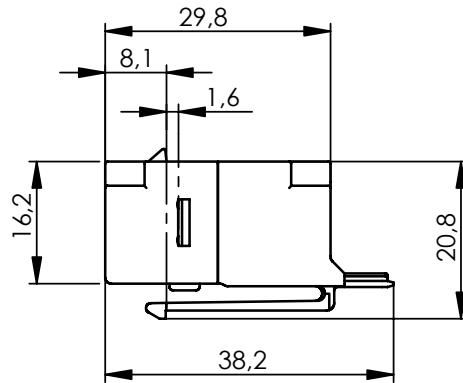
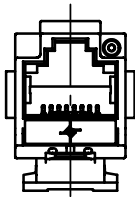
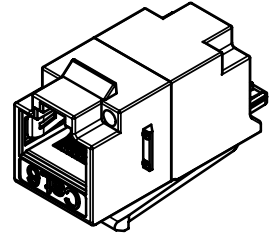
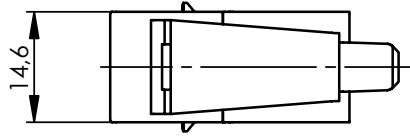
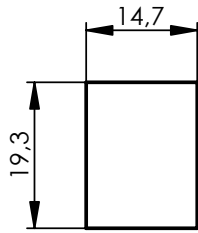
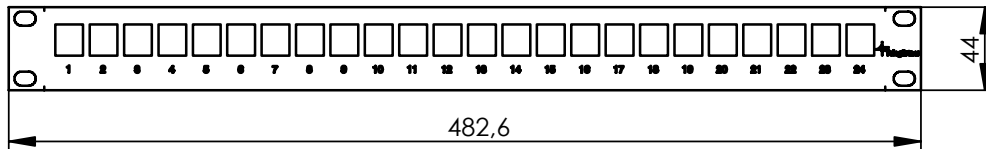



## Verpackung / packing

Skizze von Karton  
sketch from carton  
M 1:5

24 AMJ-Kupplungen in Modulträger eingeklipst und inkl. Erdungs-Set in Karton einzeln verpackt

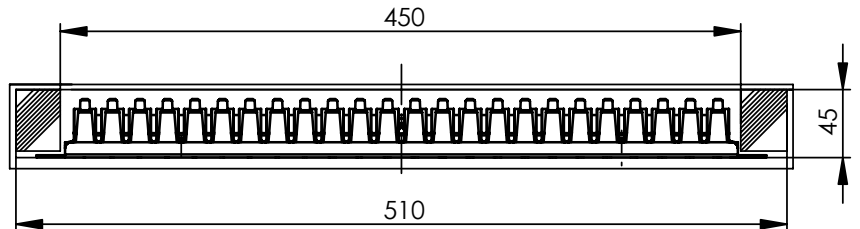
24 AMJ couplers clip on frontplate and including earthing-set single packed in carton



b	17917	31.07.06	BM	2006	Datum/ date	Name/ name	Werkstoff/ material
				gez./ drawn	23.03.	KA	
a	17844	20.06.06	ZM	gepr./ appr.	31.03.06	SK	Oberfläche/ finish
				Norm/ stand.			
Maßstab/ scale				Benennung/ title			 <b>Telegärtner</b>
1:1 (1:5)				19" Modultr. inkl. 24xAMJ-Kupplg. K Cat.6 19" frontplate incl. 24xAMJ coupl. K Cat.6			
untol. Maße/ dim. without tolerances according to				Untert./ doc. type	D		Zeichnungsnr./ drawing no. <b>J02023A0026</b>
Änderungsmittelteil/ revision code				Datum/ date		Name/ name	
And./ rev. index				Ersatz für/ replaces		Original : DIN A4 Blatt/ sheet 1 von/ of 2	

## Technische Daten / technical data

Mechanische Eigenschaften		Mechanical Characteristics
Steckkraft	≤ 20 N	insertion force
Lebensdauer (Steckzyklen)	≥ 750	life (operations)
Steckgesicht	DIN IEC 60603-7-5	mating face
<b>Werkstoffe</b>		<b>Materials</b>
Rasthaken	Zinkdruckguß / zinc diecast	snap-in hook
Isolierkörper	PA 6 weiß / white	isolation body
Gehäuse	Zinkdruckguß / zinc diecast	housing
Schirmblech	CuNi18Zn20 Neusilber / German silv er	shield
Leiterplatte	FR4	pcb
Oberfläche LP	Cu 35/35 chem. verzinkt Co 35/35 chem. tin-plated	finish pcb
Kontaktfeder	Federstahl / spring steel	contact spring
Kontaktoberfläche	min. 0.8 µm Au über / over 1,2 µm Ni	contact finish
<u>Modulträger</u>		<u>Frontplate</u>
Gehäuse	Stahlblech / sheet steel	housing
Oberfläche:		plating:
Gehäuse-Frontteil	Pulverbesch. / powder coated RAL7035	front part
Gehäuse-Rückteil	verzinkt / zinc-plated	back part
<b>Thermische und klimatische Eigenschaften</b>		<b>Thermal and climatic Characteristics</b>
Prüfklasse nach DIN IEC 60068-1	25/070/21	climatic category acc.to IEC 60068-1
<b>Elektrische Eigenschaften</b>		<b>Electrical Characteristics</b>
Kontaktwiderstand RJ45-Buchse	≤ 20 mΩ	contact resistance RJ45 jack
Isolationswiderstand	≥ 500 MΩ	insulation resistance
<b>Spannungsfestigkeit</b>		<b>Voltage proof</b>
Kontakt-Kontakt	≥ 1000 V=	contact-contact
Kontakt-Schirm	≥ 1500 V=	contact-screen
<b>Betriebsstrom bei 50°C</b>	1 A	<b>Working current at 50°C</b>
<b>Transfer-Impedanz</b>		<b>Transfer Impedance</b>
bei 1 MHz	≤ 100 mΩ	at 1 MHz
bei 10 MHz	≤ 200 mΩ	at 10 MHz
bei 80 MHz	≤ 1600 mΩ	at 80 MHz
<b>Übertragungstechnische Eigenschaften</b>		<b>Transmission Characteristics</b>
Cat.6	TIA/EIA-568-B.2-1 ISO/IEC 11801 Ausgabe / edition 2 EN 60603-7-5	Cat.6

(b)

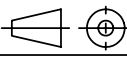
2006	Datum/ date	Name/ name	Werkstoff/ material
	gez./ drawn	23.03.	
2006	gepr./ appr.	31.03.06	SK
	Norm/ stand.		Oberfläche/ finish
Maßstab/ scale	Benennung/ title		 <b>Telegärtner</b>
	19" Modultr. inkl. 24xAMJ-Kupplg. K Cat.6 19" frontplate incl. 24xAMJ coupl. K Cat.6		
untol. Maße/ dim. without tolerances according to	Untert./ doc. type	Zeichnungsnr./ drawing no.	 Maße/ dimensions: mm
	<b>D</b>	<b>J02023A0026</b>	
And./ rev. index	Änderungsmittellung/ revision code	Datum/ date	Name/ name
a	17917 17844	31.07.06 20.06.06	BM ZM
			Ersatz für/ replaces
			Original : DIN A4 Blatt/ sheet 2 von/ of 2