



### ■ Features

- True sine wave output (THD<3%)
- High surge power up to 1000W
- High efficiency up to 88%
- High frequency design
- Thermostatically controlled cooling fan
- Protections: Bat. low alarm / Bat. low shutdown / Over voltage / Over temp. / Output short / Input polarity reverse / Overload
- Built-in 500W MPPT solar charger, MPPT efficiency:98%(Typ.)
- Built-in remote ON-OFF control
- Built-in battery low relay contact
- LED indicator for operation status and battery capacity
- 3 years warranty

### ■ Applications

- Home appliance
- Power tools
- Portable equipment
- Yacht
- Vehicle

### ■ Description

ISI-501 series integrates a DC/AC True Sine Wave Inverter and a MPPT charger. This series is a high performance true sine wave DC/AC inverter which converts the DC electricity from a system consisting of batteries and solar panels. ISI-501 is not only a high frequency designed inverter but also fully digitally controlled by an advanced microprocessor. With true sine wave output, ISI-501 series can provide 500W continuously, 550W for 60 seconds, and 1000W for 30 AC-cycles. This series incorporates a MPPT solar charger, including the constant current and constant voltage charging characteristics.

### ■ Model Encoding

ISI - 501 - 112 - A

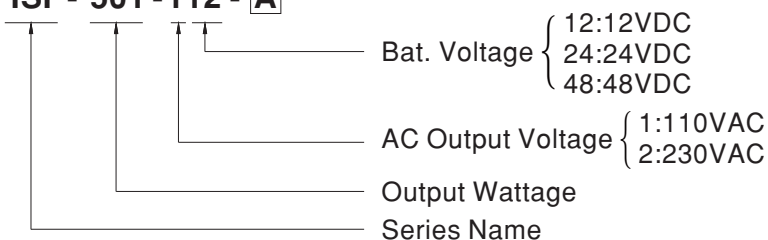

- A :TYPE A OUTLET
- B :TYPE B OUTLET
- C :TYPE C OUTLET
- D :TYPE D OUTLET
- E :TYPE E OUTLET
- F :TYPE F OUTLET
- U :TYPE U OUTLET



■ AC Output Receptacles(Optional)

Receptacle type							
	TYPE-A	TYPE-B	TYPE-C	TYPE-D	TYPE-E	TYPE-F	TYPE-U
	Standard	Standard	Optional	Optional	Optional	Optional	Optional
Country	USA	EUROPE	AUSTRALIA	U.K	JAPAN	GFCI	UNIVERSAL
Certificate	FC	CE	CE	CE	FC	FC	Non

**SPECIFICATION**

MODEL		ISI-501-112□	ISI-501-124□	ISI-501-148□	ISI-501-212□	ISI-501-224□	ISI-501-248□	
INVERTER SECTION	OUTPUT	RATED POWER	450W	500W		450W	500W	
		MAXIMUM OUTPUT POWER (Typ.)	550W for 60 sec. / surge power 1000W for 30 cycles (112, 212 models : 495W for 60 sec. / surge power 900W for 30 cycles)					
		AC VOLTAGE	Factory setting set at 110VAC 100 / 110 / 115 / 120VAC selectable by setting button S.W			Factory setting set at 230VAC 200 / 220 / 230 / 240VAC selectable by setting button S.W		
		FREQUENCY	Factory setting set at 110VAC 60 ± 0.1Hz 50/60Hz selectable by setting button S.W			Factory setting set at 230VAC 50 ± 0.1Hz 50/60Hz selectable by setting button S.W		
		WAVEFORM <small>Note.1</small>	True sine wave (THD<3%)					
		AC REGULATION (Typ.)	±3%					
		FRONT PANEL INDICATOR	Fault and operation status, Charger status, Battery capacity					
	INPUT	BAT. VOLTAGE	12V	24V	48V	12V	24V	48V
		VOLTAGE RANGE <small>Note.3,5</small>	10.5 ~ 15VDC	21 ~ 30VDC	42 ~ 60VDC	10.5 ~ 15VDC	21 ~ 30VDC	42 ~ 60VDC
		DC CURRENT (Typ.) <small>Note.7</small>	50A	30A	15A	50A	30A	15A
		NO LOAD CURRENT DRAW (Typ.)	1.25A	0.63A	0.32A	1.25A	0.63A	0.32A
		OFF MODE CURRENT DRAW (Typ.)	≤ 1mA					
	EFFICIENCY (Typ.) <small>Note.2</small>	85%	87%	87%	86%	88%	88%	
	OUTPUT PROTECTION	OVER TEMPERATURE	Shut down o/p voltage, re-power on to recover					
		OUTPUT SHORT	Shut down o/p voltage, re-power on to recover					
OVER LOAD (Typ.)		110% load for 60 sec. Protection type : Shut down o/p voltage, re-power on to recover						
BATTERY SECTION	CHARGER CURRENT (Typ.)	30A	17A	8.5A	30A	17A	8.5A	
	BATTERY TYPE	Open & sealed Lead Acid						
	FUSE	40A*2	40A*1	20A*1	40A*2	40A*1	20A*2	
	BAT. LOW ALARM <small>Note.3</small>	11.3V	22.5V	45V	11.3V	22.5V	45V	
	BAT. LOW SHUTDOWN <small>Note.3</small>	10.5V	21V	42V	10.5V	21V	42V	
	REVERSE POLARITY	By internal fuse open						
MPPT / SOLAR SECTION	MPPT CHARGER EFFICIENCY (Typ.)	98%						
	OPEN CIRCUIT VOLTAGE RANGE	35 ~ 50V	45 ~ 90V	90 ~ 160V	35 ~ 50V	45 ~ 90V	90 ~ 160V	
	MPPT RANGE	25 ~ 50V	35 ~ 90V	70 ~ 160V	25 ~ 50V	35 ~ 90V	70 ~ 160V	
	SOLAR INPUT CURRENT (Typ.)	11A	7A	4.5A	11A	7A	4.5A	
	SOLAR INPUT POWER (Typ.)	500W						
GENERAL SECTION	ENVIRONMENT	WORKING TEMP. <small>Note.4</small>	-20 ~ +40°C @ 100% load ; 60°C @ 50% load					
		WORKING HUMIDITY	20% ~ 90% RH non-condensing					
		STORAGE TEMP., HUMIDITY	-30 ~ +70°C / -22 ~ +158°F, 10 ~ 95% RH non-condensing					
		VIBRATION	10 ~ 500Hz, 3G 10min./1cycle, 60min. each along X, Y, Z axes					
	SAFETY & EMC	LVD	None				EN60950-1 (LVD)	
		WITHSTAND VOLTAGE	Bat I/P - AC O/P:3.0KVAC AC O/P - FG:1.5KVAC					
		ISOLATION RESISTANCE	Bat I/P - AC O/P, Bat I/P - FG, AC O/P - FG: 100M ohms / 500VDC / 25°C / 70% RH					
		EMC EMISSION	Compliance to FCC part 15 class B				Compliance to EN55032 class B	
		EMC IMMUNITY	None				Compliance to EN61000-4-2,3,8	
	OTHERS	MTBF	57.8K hrs min. MIL-HDBK-217F (25°C)					
		DIMENSION	205*158*67mm (L*W*H)					
		PACKING	2.35Kg; 6pcs/15.1Kg/1.55CUFT					
NOTE	<p>1. THD is tested by rated power, linear load at 13V,26V,52V input voltage.                  2. Efficiency is tested by 350W, linear load at 13V,26V,52V input voltage.                  3. The tolerance of each voltage value by models is : 112/212→±0.5V ; 124/224→±1V ; 148/248→±2V.                  4. Output derating capacity referenced by curve 1.                  5. Input derating capacity referenced by curve 2.                  6. All parameters not specified above are measured at rated load, 25°C of ambient temperature and set to factory setting.                  7. DC current is tested by 500W, linear load at 12V,24V,48V input voltage.</p>							

■ Block Diagram

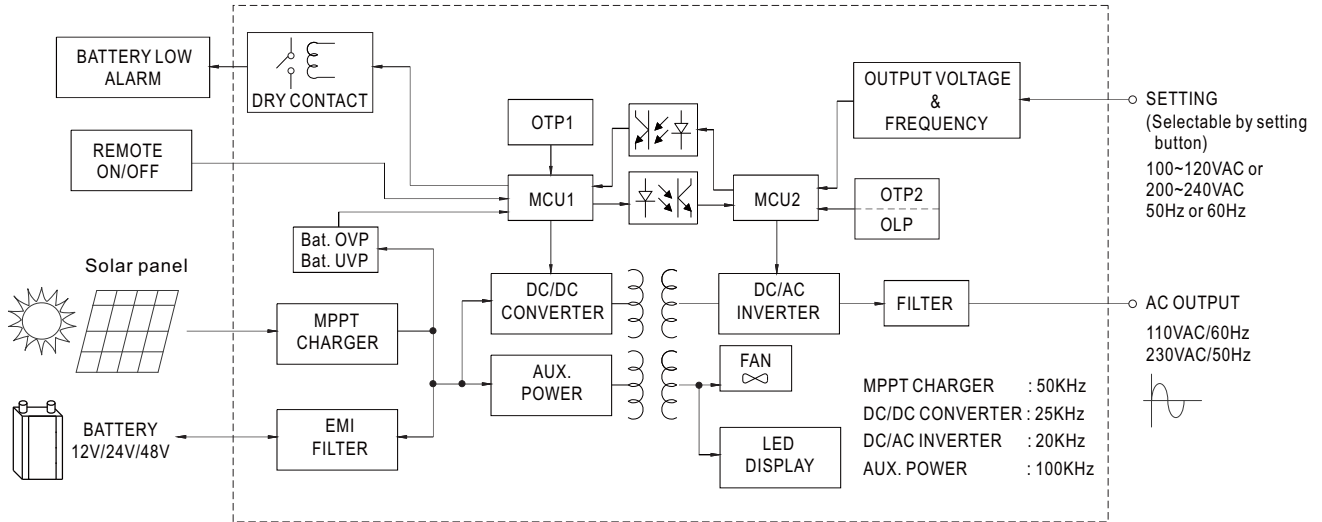

■ Derating Curve

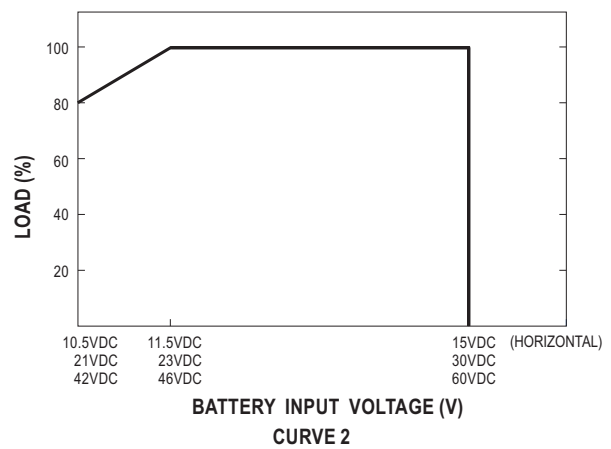
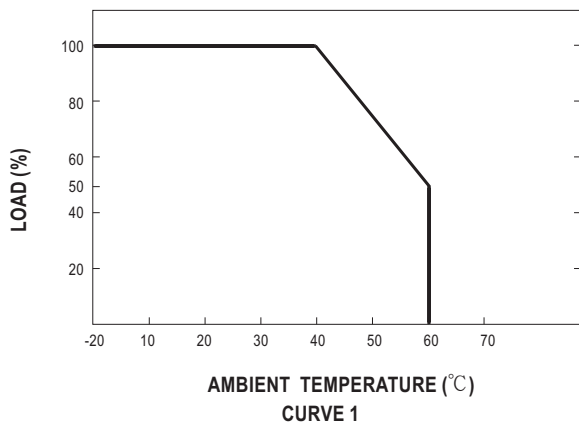

■ Charging Curve

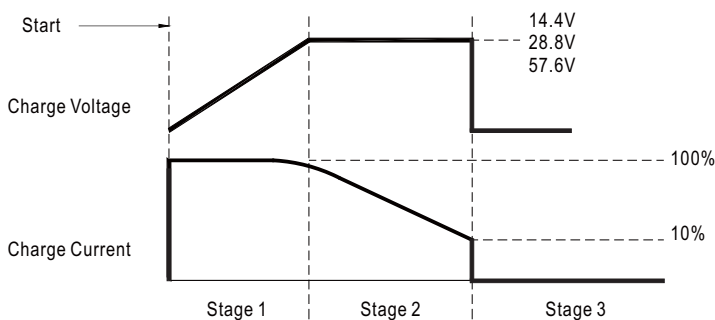

- Stage 1 : Constant Current
- Stage 2 : Constant Voltage
- Stage 3 : MPPT Charger OFF

\*Constant current condition : Dependent on solar input current and MPPT voltage of solar panel.

\*MPPT charger OFF condition: Charge current less than 10% rated charge current and solar input power under 50W.

### Mechanical Specification

Case No.805 Unit:mm

#### Input Terminal Pin No. Assignment

Pin No.	Assignment	Pin No.	Assignment
1	Battery Input NEG(-)	5	FG $\perp$
2	Battery Input POS(+)	6	Bat. Low Alarm Connector
3	Solar Input NEG(-)	7	Remote ON/OFF Connector
4	Solar Input POS(+)		

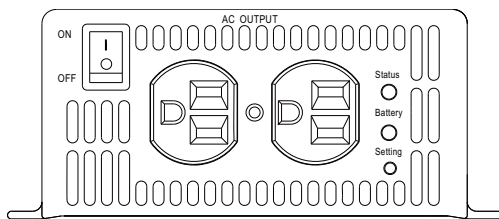
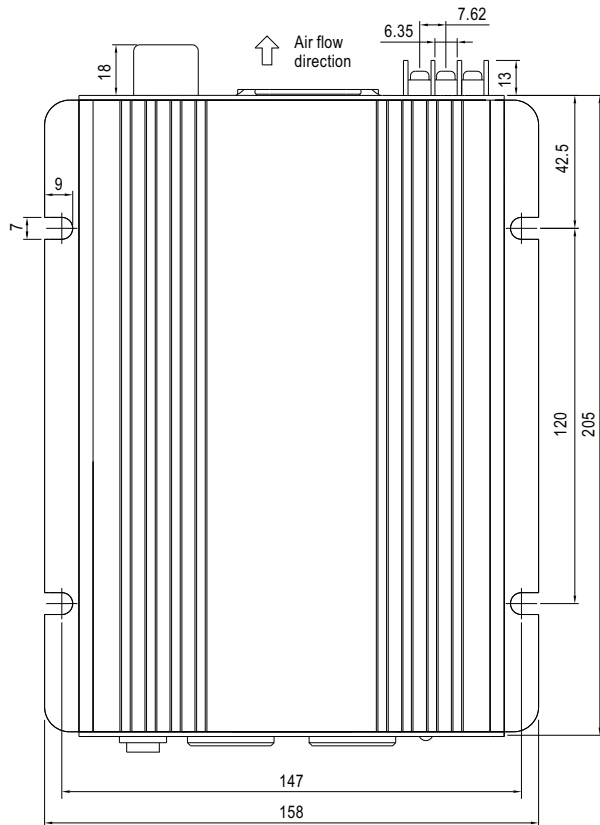
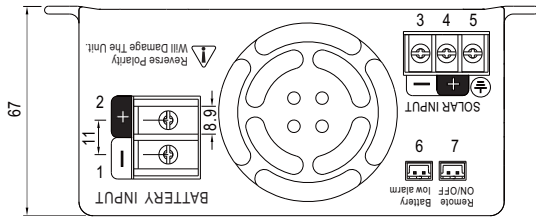

Type-A

### Function Manual

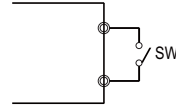

Remote ON/OFF Connector

Remote ON/OFF Connector :  
JST B-XH or equivalent

Open	Normal work
Short	Remote off

Relay dry contact  
Contact Rating :  
1A @ 24VDC resistive

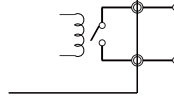

Bat. Low Alarm Connector

Bat. Low Alarm Connector :  
JST B-XH or equivalent

Open	Battery low
Short	Battery OK

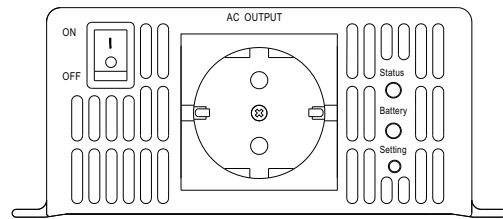

Type-B