

# SYNERGY 21<sup>®</sup>

"SYNERGY 2<sup>®</sup>" for black printing The pantone of Color is grey  
 "1" for blue printing The pantone of Color is 298C

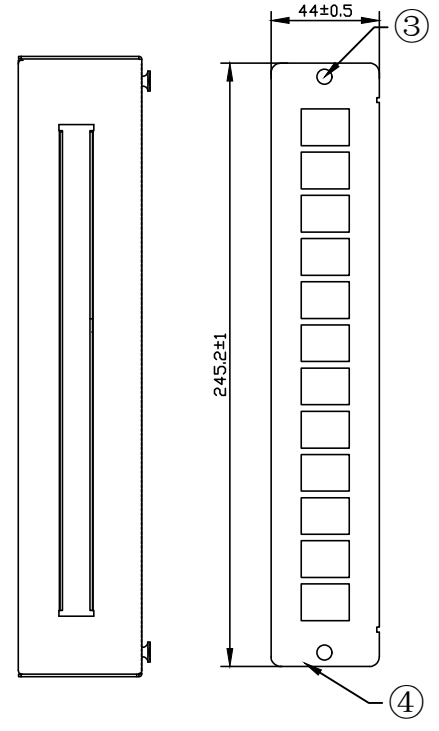
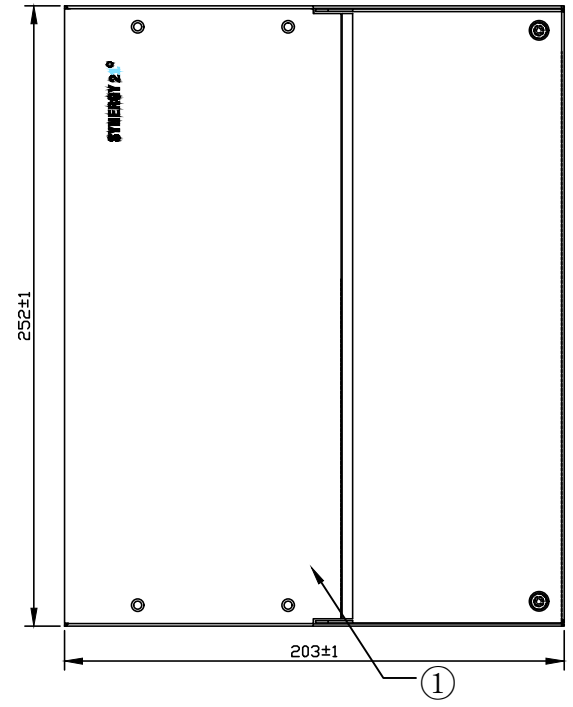
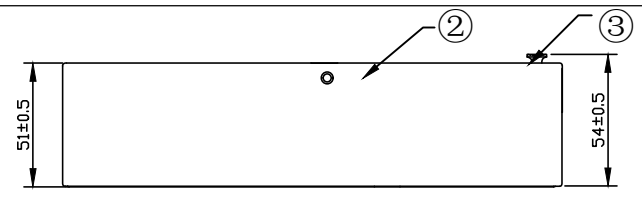

**NOTE:**

1. Suitable for copper and fiber optic technology
2. Expandable for installation on DIN rails with optional accessories (S216385)
3. Cable input and cable output with cable management and dust-proof foam
4. Protection type: IP20
5. RoHS3.0 AND REACH COMPLIANT
6. Storage temperature : -20°C+80°C
7. Operation temperature: -10°C+60°C
8. Packing:1pc/Box+label

**MATERIAL LIST:**

④	Panel	12port for RJ45 Keystone modules SPCC T=1.0MM with plastic powder cladding	1	
③	Push and pull buckle	BLACK	4	
②	Top Cover	SPCC T=1.0MM with plastic powder cladding	1	
①	Bottom Panel	SPCC T=1.0MM with plastic powder cladding	1	
NO.	PARTS NAME	SPECIFICATION DESCRIPTION	QT'Y	REMARK
		NEW	2023-03-27	A
BY	CHK	REVISION RECORD MODIFICATIONS	DATE	REV.

<b>SYNERGY21</b>					
CUSTOMER		ITEM NO.		S216384	
PRODUCT NAME		manufacture country:		CHINA	UNIT MM
Consolidation Point Box		APPOBY		DATE	
DRAWNBY		CHECKBY		DATE	
SYNERGY21		SYNERGY21		2023-03-27	

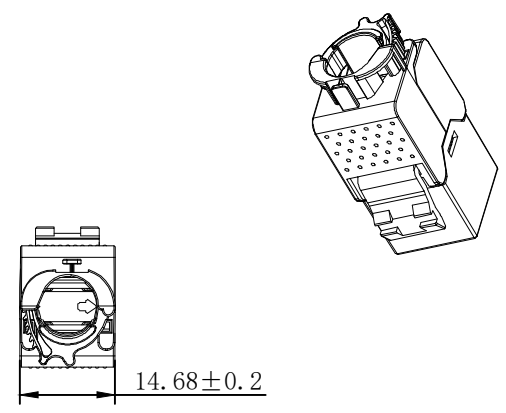
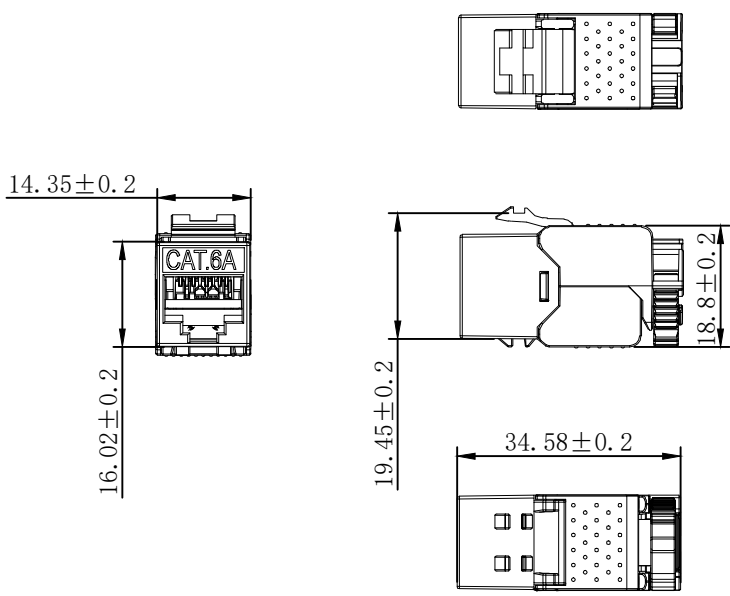

NOTES:

ELECTRICAL:

- Contact Resistance : 20MΩ MAX
- Insulation Resistance : 500MΩ MIN @ 500V DC
- Withstand Voltage : DC 1000V AC 700V RMS 60Hz, 1MIN
- Compliance with Class EA up to 500 MHz to ISO/IEC 11801 Ed.2.2:2011-06  
DIN EN 50173-1:2011-09  
TIA/EIA-568-C.2 (2009-08)  
IEC 60603-7 Ed.1 (12/2008)

ENVIRONMENTAL:

- Storage temperature : -40° TO+70°
- Operation temperature : -10° to+60°

MECHANICAL

- SHIELD MATERIAL: ZINC ALLOY
  - IDC MATERIAL: PC TERMINAL:PHOSPHOR BRONZE, TIN PLATING
  - RJ45 Contact Life: 750 Times Min
  - Plug inforce:<30N
  - Solid cable:1/22AWG(0.65MM)-1/26AWG(0.40MM) ID:1.05MM-1.5MM
  - Cable OD: 5.0mm-8.0mm
  - PoE per IEEE 802.3af, PoE+ per IEEE 802.3at
  - 360° Shield connection
- Packing: 1pc/PE bag+lable  
(copper foil included)  
RoHS 3.0 and REACH Compliant

MATERIAL LIST:

⑦	IDC TERMINAL	FOR 22-26AWG (0.45mm-0.65mm) CABLE	1	
⑥	LABEL COLOR CODE	T568A/B	2	
⑤	IDC PIN	PHOSPHOR BRONZE & TINNED	8	
④	IDC BODY	FIREPROOF/PC UL 94V0	1	
③	PCB	1.2mm UL 94V0	1	
②	RJ 45 JACK INSERT	PHOSPHOR BRONZE 8P8C GOLD PLATED	8	
①	MODULAR COVER	ZINC ALLOY	1	
NO.	PARTS NAME	SPECIFICATION DESCRIPTION	QT'Y	REMARK
		NEW	2022-12-06	A
BY	CHK	REVISION RECORD MODIFICATIONS	DATE	REV.

SYNERGY21

CUSTOMER		ITEM NO.	S216382		
PRODUCT NAME	Super slim Cat.6A/Class EA Keystone Jack	manufacture country:	CHINA	UNIT	MM
DRAWNBY	CHECKBY	APPOBY	DATE		
SYNERGY21	SYNERGY21	SYNERGY21	2022-12-06		

# Installationsanleitung/Installation guide

## Keystone Jack

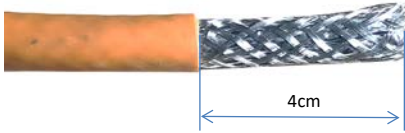

①.Stripping 4cm of sheath.



②.foldback braided and drained wire.



③.paste copper foil on the braided and ground wire and cut off the excess weave and the ground wire



④.4.Fan out all four twisted pairs, allocate each by following colorcoding label



⑤.Across the holde by the color marks of T568A or T568B

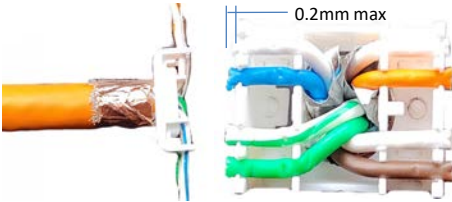

⑥. allocate each conductor into proper slots on wiring cap by following color coding



⑦.Trim the theends of conductors.



⑧.install the termination cap in direction of arrow into the keystone jack

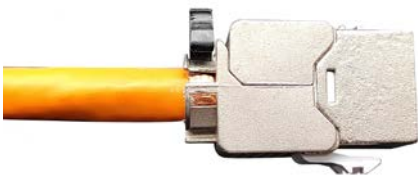

⑨.press both covers of the keystone jack to contact the cable



⑩.Fasten smart cable ties for 360 degree shielding