

9W Dual White Magnetic Chandelier (2.4GHz)

Model No.: MC2-09B-ZR

Product Feature

- ZIGBEE3.0 standard protocol
- brightness and color temperature adjustable
- Narrow beam angle 15°, deep anti-glare designing with best central lighting performance
- 4096 smooth dimming level, mini brightness 0.1%
- Control Distance:30m
- Control multi lights at the same time
- Signal auto transmitting: transmit signal to each lights and unlimited control distance
- Have DND function, usually used in power failure area to save power
- Support "TUAY SMART" APP control (need to connect with 2.4G gateway)
- Support Alexa,Google Assistant,Yandex Alice,Tmall genie,Bai Du, Xiao Mi (need to connect with 2.4G gateway)
- 48V low voltage with simple magnetic installation



Product Parameter

Product Name: 9W Dual White Magnetic Chandelier	IP rate: IP20
Model No.: MC2-09B-RF	Working Temperature: -10~40°C
Input voltage: DC48V	Dimming Level: 4096
Power: 9W	Dimming Range: 0.1~100%
CRI: >90	Dimming Curve: logarithm
Color temperature: 2700~6500K	EMC Standard (EMC): ETSI EN 301 489-1 V2.2.3 ETSI EN 301 489-3 V2.3.2
Luminous Flux: 600LM	ET IEC 60598-1:2021+A11:2022
Luminous efficiency: 66LM/W	Security Standard (LVD): EN 60598-2-2: 2012 EN IEC 62031:2020+A11:2021 EN 62498:2015+A1:2022
Beam Angle: 15°	Radio equipment (RED): ETSI EN 300 400 V2.2.1
Protocol: Zigbee 3.0 + 2.4GHz RF	Certification CE、EMC、LVD、RED
Control Distance: Zigbee: 50M(open area)/ 2.4G RF: 30M	

Dimension

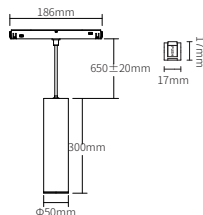

Installation Tips

Please read instruction before installing it, you can contact with our service center if there is any technical issue

1



Plastering Mounted



Flush Mounted



Surface Mounted

Compatible with 20 style rail

2

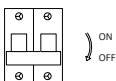

Turn off mains

3

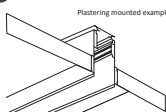

Select 20 style rail and fix it

4

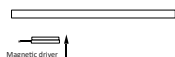

Install magnetic driver

5

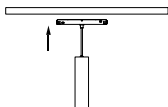

Insert the light into rail

6

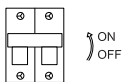

Turn on mains after installation

7

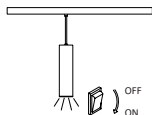

Inspecting the status of light

Lighting source can not be replaced, please buy new light if the light is over lifetime

Auto transmitting

signal auto transmitting

The light receive signal from remote and auto transmitting to another lights within 30m, it can extend unlimited distance



Light

Auto transmitting



Distance 30m

Light



Link/Unlink

Link controller must link with remote before using it

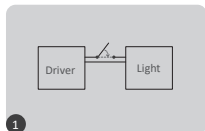

turn off light 10 seconds and turn on again



short press "ON" 3 times within 3 seconds

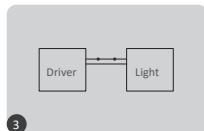

link is done once light flashes 3 times slowlyyy



Link is failed if light doesn't flash, please repeat above steps (Attention: can not link again if remote already finished linking)

Unlink:

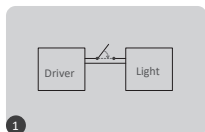

turn off light 10 seconds and turn on again



short press "ON" 5 times within 3 seconds

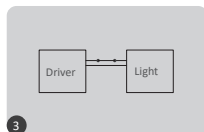

link is done once light flashes 10 times quickly



Unlink is failed if light doesn't flash, please repeat above steps (Attention: no need to unlink if the light never be linked)

Compatible Remote (purchase separately)



FUT094



FUT006



FUT007



FUT087/ FUT087-B



B1/ B1-B/ T1



B2/ T2



K1/ K1-B



K2/ K2-B



K3



C1



C3



Y2

DND mode ON/OFF (factory default is ON)

Turn ON DND:

Short press "OFF" 3 times within 3 seconds and short press "ON" 3 times, DND mode is activated if the light flashes 4 times quickly

Attention: The status of light (ON or OFF) is same as turn on or off mains

Turn off DND

Short press "ON" 3 times within 3 seconds and short press "OFF" 3 times, DND mode is shut down if the light flashes 4 times slowly

Attention: The light is always ON if turn on or off mains

APP Instruction

It must connect with Zigbee 3.0 gateway and add gateway into "TUYA SMART"APP (please check gateway instruction)

- 1.Connect with mains
- 2.Enter into network pairing mode (factory default is network pairing mode)
- Solution: Turn ON and Turn OFF light 3 or over 3 times continuously, the light status is breathing
- 3.Go to "TUYA SMART" APP main page and click gateway, click" Add subdevice"
- 4.Click " indicator is flashing quickly"
- 5.Dimming or group control... etc after adding successfully

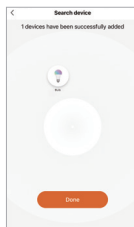
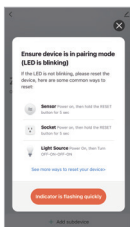
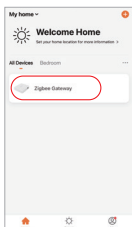

Turn ON or OFF DND (factory default is ON)

Click the light or the group - click " more" -Click "Power-on behavior"

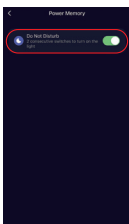
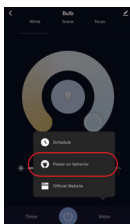
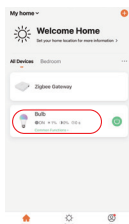

Philips Hue Instruction

It must connect with Philips Hue and add device into "Philips Hue" APP

- 1.Connect with mains
- 2.Enter into network pairing mode (factory default is pairing mode)
- Solution: turn off and turn on light 3 or over 3 times continuously, the light is breathing
- 3.Enter into "Philips Hue"APP main page and click "SETTINGS", click "Lights"
- 4.Click "+"
- 5.Click " Search"
- 6.Searching device for a while and click "Start configuration", finish the steps

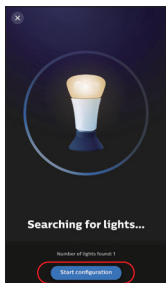
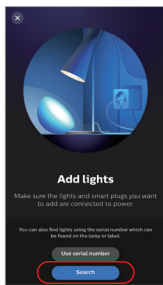
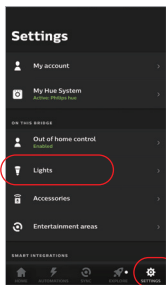

Alexa voice control instruction

1. Alexa control (Audio conform to zigbee 3.0 protocol)

Amazon Echo can connect with device directly, the following model already conformed to zigbee 3.0 protocol)

Amazon ECHO Plus (2nd Gen), ECHO (4th Gen), ECHO Studio, ECHO Show (2. Gen)

1). Connect with mains

2. Enter into network pairing mode (factory default is pairing mode)

Solution: turn off and turn on light 3 or over 3 times continuously, the light is breathing

3. Speak to Amazon Echo " Alexa, Discover devices",

search device for a while and control via your voice command directly

"Alexa, Discover devices"



2). Alexa control (audio is not built in zigbee 3.0 protocol)

Please add device into Miboxer zigbee 3.0 gateway firstly

1) . Enter into Alexa APP

2) . Click "More"

3) . Click "Skills& Games

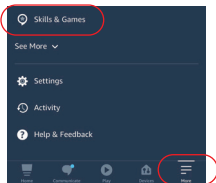

4) . Click " Q "

5) . Type into "smart life" and search



6) . Click "smart life" skills and finish the steps

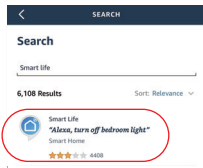

Google Home voice control

Please add device into Miboxer zigbee 3.0 gateway

- 1) . Enter into Google Home APP
- 2) . Click "+"

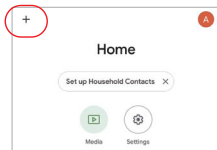

- 3) . Click "Set up device"

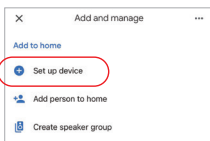

- 4) . Click "works with Google"

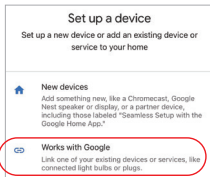

- 5) . Click " Q "
- 6) . Type into "Smart life" and search
- 7) . Click "smart life" skills and finish the steps

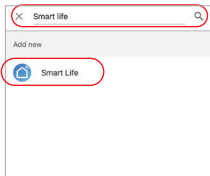

Connection Diagram

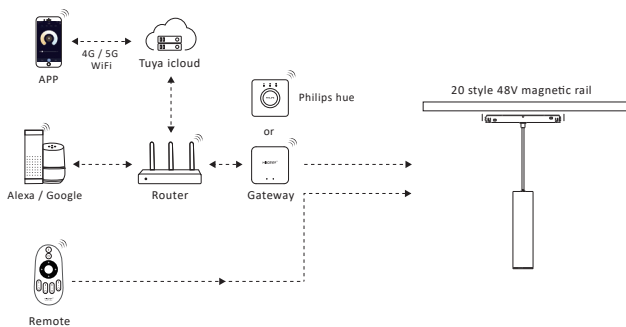

Attention

1. Please ensure that voltage, N and L are correct connection, it will damage the light with wrong wiring
2. Please turn off mains before wiring cable and ensure that connection don't have any problem like short circuit
3. Don't disassemble it if you are not expert
4. Don't use it near magnetic or metal area, it will affect signal and reduce distance.



Made in China