

SYNERGY 21[®]

- NOTE:
- PANEL FRAME:SPCC T=1.5MM with plastic powder cladding Frosting surface treatment
 - Mounting plate Nickel Plating T=1.5MM
 - PANEL BRACKET SPCC T=1.5MM with plastic powder cladding Frosting surface treatment
 - BODY COLOR: Gray "1 2 3.....24" Color: black Font : Arial H:4.4MM
 BODY COLOR: Black "1 2 3.....12" Color: white Font : Arial H:4.4MM Color: white
 - Accessory:
 - Cable Tie (75X1.9mm) *24pcs
 - Screw and Nut M6*18mm × 4set
 - RoHS 3.0 and REACH Compliant
 - Packing:1pc/PE bag+Inner box 10pcs/outcarton

PANEL COLOUR GRAY: "SYNERGY 2" for black printing The pantone of Color is black C
 "1" for blue printing The pantone of Color is 298C

PANEL COLOUR BLACK: "SYNERGY 2" for silver printing The pantone of Color is 877C
 "1" for blue printing The pantone of Color is 298C

ITEM NO.	Colour
S216336V2	Gray RAL 7035
S216337V2	Black RAL 9005

SYNERGY 21									
CUSTOMER			ITEM NO.		MANUFACTURE COUNTRY:				
PRODUCT NAME			19" 1U 24 ports STP blank Patch panel Three-piece type		CHINA UNIT MM				
DRAWNBY			CHECKBY		APPOBY		DATE		
SYNERGY 21			SYNERGY 21		SYNERGY 21		2020-02-21		

NEW			2020-02-21		A	
REVISION RECORD MODIFICATIONS			DATE		REV.	
BY	CHK					

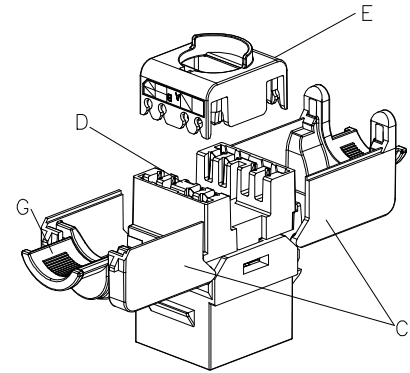
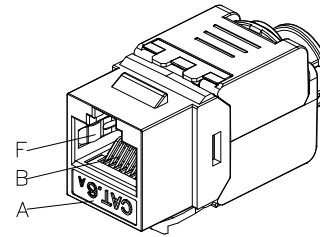
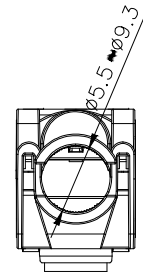
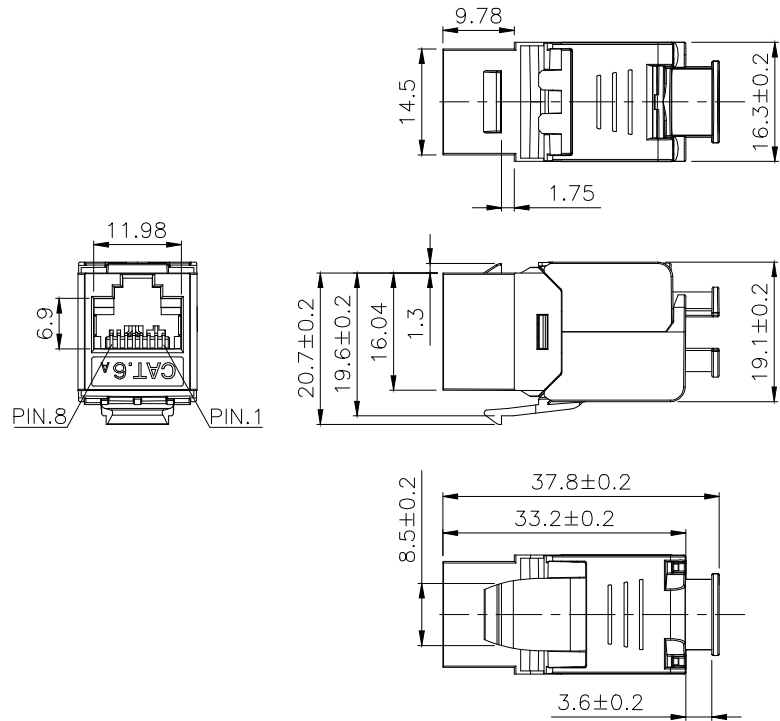

NOTES:

ELECTRICAL:

- 1. Contact Resistance : 20MΩ MAX
- 2. Insulation Resistance : 500MΩ MIN @ 500V DC
- 3. Withstand Voltage : DC1000V AC700V RMS 60Hz, 1MIN

ENVIRONMENTAL:

- 1. Storage : -40° TO+70°
- 2. Operation : -10° to+60°

MECHANICAL

- 1. SHIELD MATERIAL: ZINC ALLOY
- 2. IDC MATERIAL: PC UL94V2 TERMINAL:PHOSPHOR BRONZE, TIN PLATING
- 3. IDC Life : 250 Times Min
- 4. Support PoE per IEEE 802.3af, PoE+ per IEEE 802.3at
- 5. RJ45 Contacts durability:750 cycles min
- 6. For cable AWG 23/1-26/1(1/0.40-1/0.58mm)
- 7. For cable OD:5.5-9.0mm

ISO/IEC 11801-1

EIA/TIA 568-C

IEC 60603-7-51

RoHS 2.0 and REACH Compliant

Accessories

▪Cable Tie(75X1.9mm) *1Pc

▪Copper foil*1Pc

Function test: AEM MMVAN-200+VNA Manager TEST

Website: <https://aem-test.com/>

(Random test 0.3%)

SinglePack: 1pc/PE bag+label; SubPack: 25pcs/box+label; Carton +labelx2;

MATERIAL LIST:

⑦	MODULAR COVER	PC UL94V2	1	
⑥	RJ 45 JACK INSERT	8P8C GOLD PLATED	8	
⑤	PCB	1.0mm UL 94V0	1	
④	IDC BODY	PC UL 94V2	1	
③	IDC PIN	PHOSPHOR BRONZE & TINNED	8	
②	LABEL COLOR CODE	T568A/B	2	
①	IDC TERMINAL	FOR 23-26AWG CABLE	1	
NO.	PARTS NAME	SPECIFICATION STANDARD	QT' Y	REMARK

SYNERGY21

					CUSTOMER				ITEM NO.	S216379		
					PRODUCT NAME	Components Cat.6A Keystone Jack 180 degree Slim Type			manufacture country:	CHINA	UNIT	MM
					NEW	2021-11-16	A0	DRAWNBY	CHECKBY	APPOBY	DATE	
BY	CHK	REVISION RECORD MODIFICATIONS			DATE	REV.	SYNERGY21	SYNERGY21	SYNERGY21	2021-11-16		

Installationsanleitung/Installation guide

Super slim Cat.6A Keystone Jack

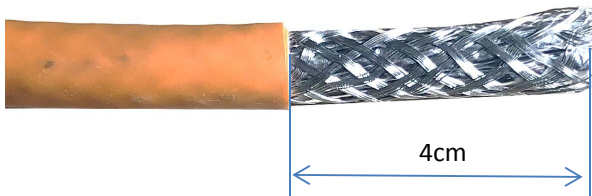

①.Stripping 4cm of sheath.

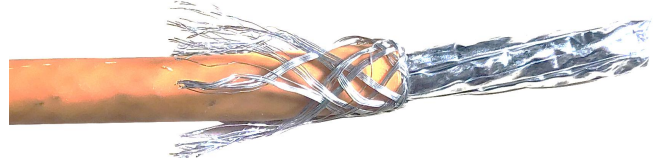

②.foldback braided and drained wire.

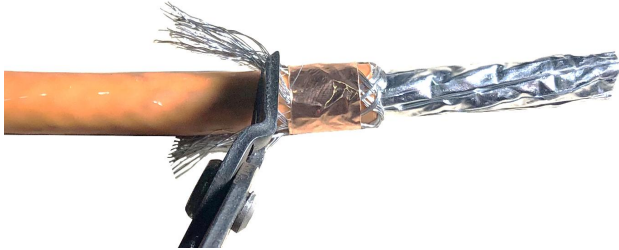

③.paste copper foil on the braided and ground wire and cut off the excess weave and the ground wire

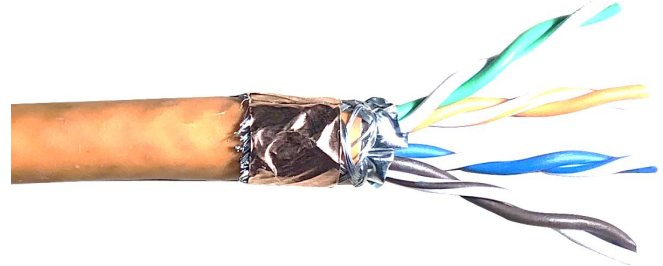

④.4.Fan out all four twisted pairs, allocate each by following colorcoding label

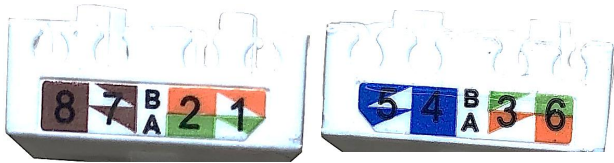

⑤.Across the holde by the color marks of T568A or T568B

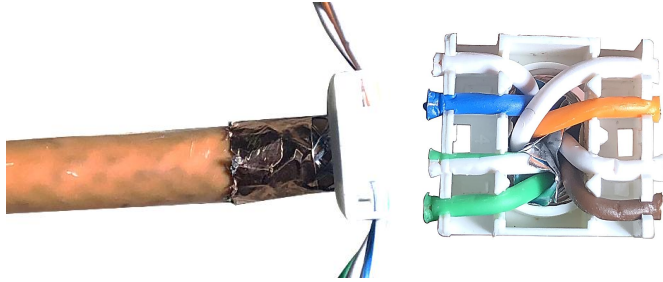

⑥. allocate each conductor into proper slots on wiring cap by following color coding



⑦.Trim the theends of conductors.

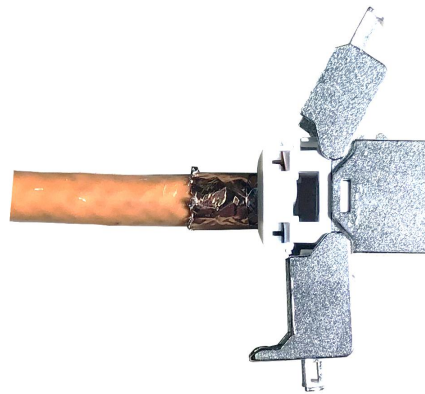

⑧.install the termination cap in direction of arrow into the keystone jack

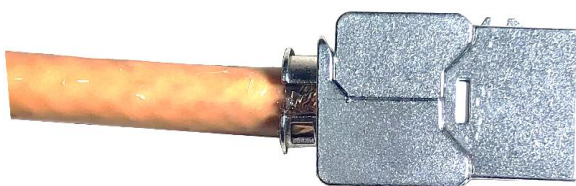

⑨.press both covers of the keystone jack to contact the cable

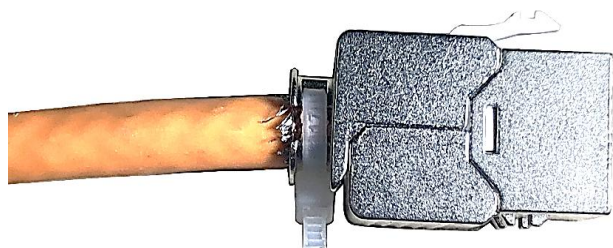

⑩.use cable tie for strain relief and to fix the shielding clamp