

③	Screw	M5	1PCS	
②	keystone Jack holder	Material:stainless steel	1PCS	
①	DIN Rail	Material:stainless steel	1PCS	
NO.	PARTS NAME	SPECIFICATION STANDARD	QT' Y	REMARK
		NEW	2017. 04. 28	A
BY	CHK	REVISION RECORD MODIFICATIONS	DATE	REV.

SYNERGY 21				
CUSTOMER		ITEM NO.	S215486	
PRODUCT NAME	1port RJ45 keystone Jack holder for DIN Rail Metal	manufacture country:	CHINA	UNIT MM
DRAWNBY	CHECKBY	APPOBY	DATE	
SYNERGY 21	SYNERGY 21	SYNERGY 21	2017. 04. 28	

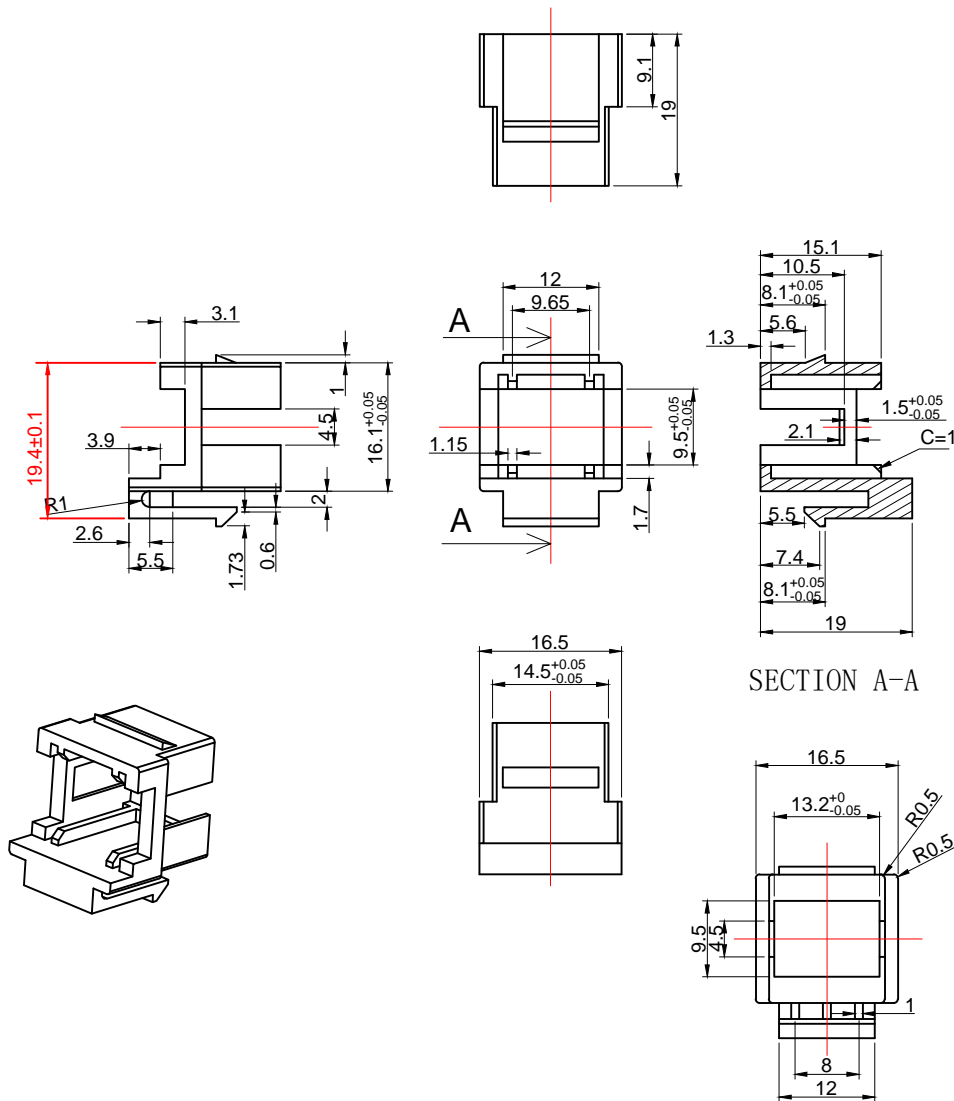

SECTION A-A

NOTES:

1. ABS Black
2. Keystone for LC duplex/SC simplex no flange Adapte
2. Packing: 1pc/PE Bag+Lable
3. ROHS2.0 AND REACH COMPLIANT

SYNERGY 21					
CUSTOMER		ITEM NO.	S215479		
PRODUCT NAME	Keystone adapter	manufacture country:	CHINA	UNIT	MM
DRAWNBY	CHECKBY	APPOBY	DATE		
SYNERGY 21	SYNERGY 21	SYNERGY 21	2017-05-03		

BY	CHK	REVISION RECORD MODIFICATIONS	DATE	REV.
		NEW	2017-05-03	A

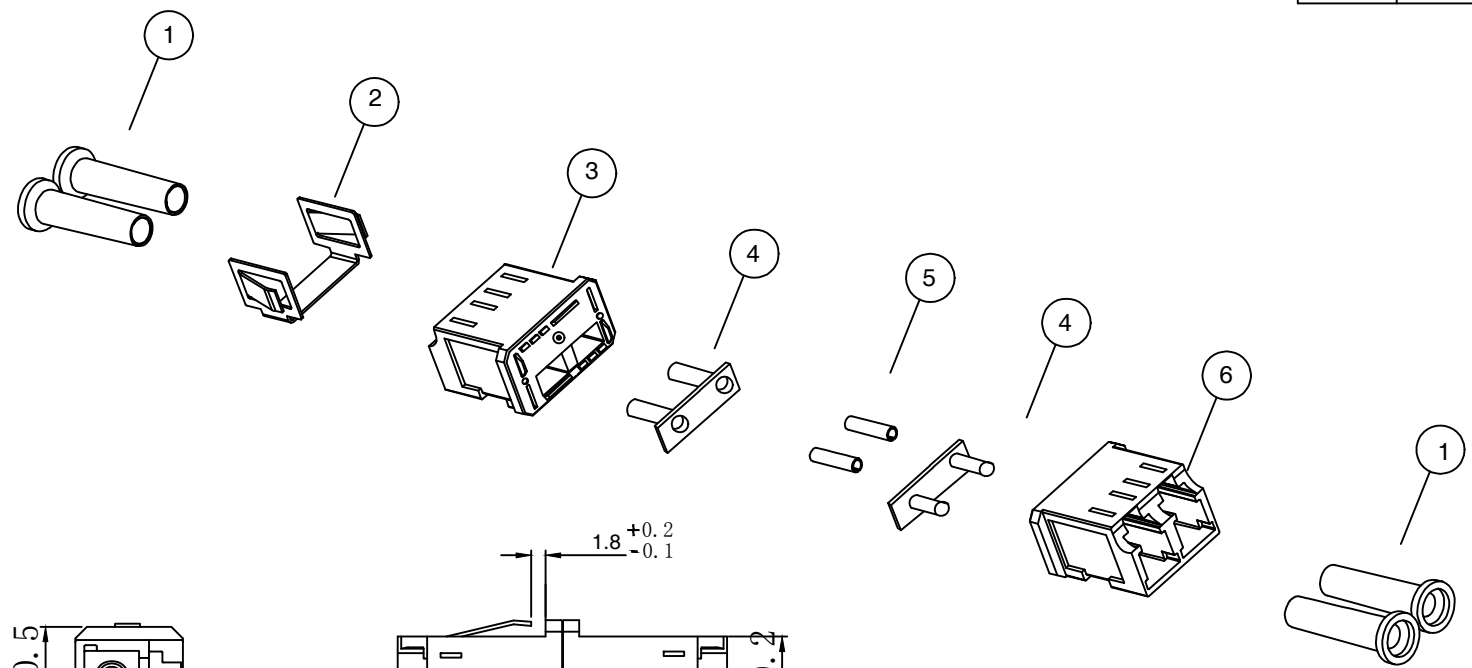

NOTE:
RoHS 2.0 & REACH COMPLIANT

Insertion Loss(dB)	≤0.20
Operating Temperature(° C)	-40 ~ +80
Storage Temperature(° C)	-40 ~ +85

MATERIAL LIST:

⑥	LC Plastic body Lime Green (SC simplex footprint)	1pcs	
⑤	LC Sleeve ceramic (Multi-Mode)	1pcs	
④	Bush Lime Green	2pcs	
③	LC Plastic body Lime Green (SC simplex footprint)	1pcs	
②	LC Metal Mount	1pcs	
①	LC White Dust Cap	4pcs	

Chart:

NO.	ITEM NO.	EAN Number
1	S215509	4038816074034

NO.	SPECIFICATION STANDARD	QT' Y	REMARK
	NEW	2018-3-21	A
BY	CHK	REVISION RECORD MODIFICATIONS	DATE

SYNERGY 21					
CUSTOMER		ITEM NO.	See the chart		
PRODUCT NAME	LC MM Lime Green (ceramic) Duplex Plastic Adapter(SC SX Footprint) w/o flange	Manufacture Country	CHINA	UNIT	MM
DRAWNBY	CHECKBY	APPOBY	DATE		
SYNERGY 21	SYNERGY 21	SYNERGY 21	2018-3-21		