

ALL-CAM2395-ALL-CAM2395- LVEF_Ceiling_Mount

In-ceiling Mount Bracket for Dome Camera



Features:

For in-ceiling mounting
Aluminum alloy material with surface spray treatment

Dimension:

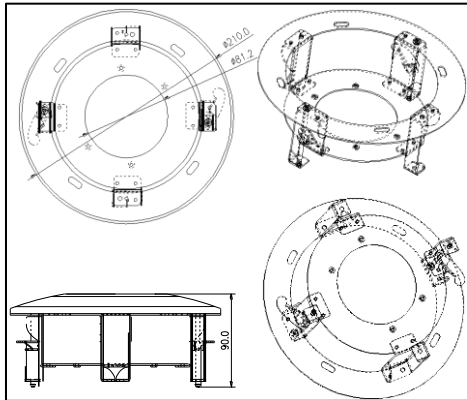

Model Suitable:

ALL-CAM2395-LVEF & ALL-CAM2395v2-LVEF

Installation Step:

① Choose flat wall for installation and screw up the adaptor

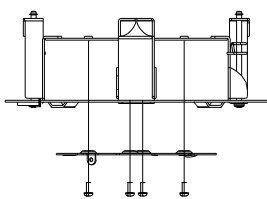

② Complete the adaptor installation

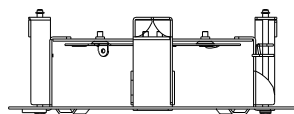

③ Screw up the dome camera

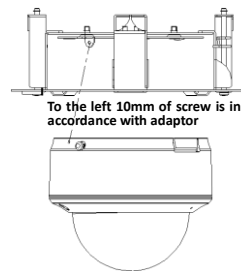

④ Insert the dome camera and bracket to the wall

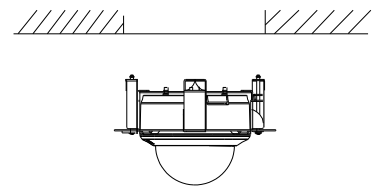

⑤ Screw up the butterfly clamp in clock-wise and clamp the bracket to the wall

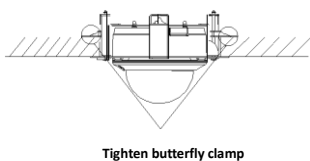

⑥ Tighten 3 screws to fix cap ring

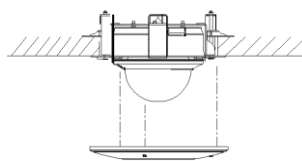

⑦ Installation complete

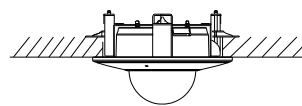

Order Model:

124891 - ALL-CAM2395-LVEF_Ceiling_Mount



Parameter:

Model	Art. 124891.
Parameter	In-ceiling Mount Bracket
Appearance	Hik White
Range of Application	Dome Camera
Material	Aluminum Alloy
Dimension	210×90mm
Weight	600g

Notice:

The bracket should be installed on flat wall
The wall must be capable of supporting more than 3 times the weight of camera and bracket
Load capacity of bracket is **4.5KG**

Note: The actual bracket may vary from the picture above.