

SYNERGY 21[®]

"SYNERGY 2[®]" for black printing The pantone of Color is black c

"1" for blue printing The pantone of Color is 298C

NOTE:

1. PANEL FRAME:SPCC CARBON STEEL T=1.2MM POWDER COATING
2. PANEL BRACKET SPCC NICKEL PLATING
3. Apply to the keystone jack which the width less than 17.4mm
4. BODY COLOR: Gray RAL 7035 "1 2 3.....8" Color: black Font : Arial H:4.4MM
5. Accessory:

1. Cable Tie(75X1.9mm) *8pcs
 2. expanded screw X 2 Set
- ROHS2.0 AND REACH COMPLIANT

SYNERGY 21

						SYNERGY 21				
					CUSTOMER		ITEM NO.	S216334		
					PRODUCT NAME	Mini 8 ports desktop blank Patch panel Toolless	manufacture country:	CHINA	UNIT	MM
		NEW		2016-01-15	A	DRAWNBY	CHECKBY	APPOBY	DATE	
BY	CHK	REVISION RECORD MODIFICATIONS			DATE	REV.	SYNERGY 21	SYNERGY 21	2016-01-15	

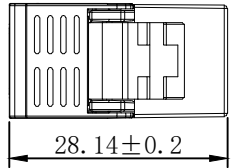
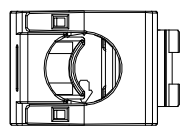
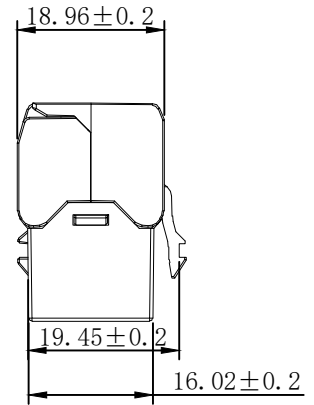
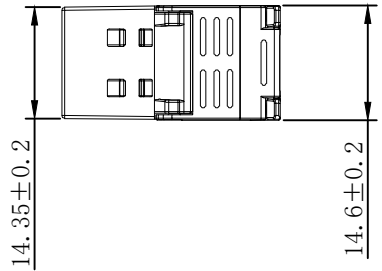

NOTE:

ELECTRICAL

1. Contact Resistance :200Ω MAX
2. Insulation Resistance :500Ω MIN @ 500V DC
3. Withstand Voltage :DC 1000V AC 700V RMS 60Hz, 1MIN

ENVIRONMENTAL:

Storage : -40°C TO+70°C
 Operation: -10°C TO+60°C

MECHANICAL

1. SHIELD MATERIAL:ZINC ALLOY (Silver)
2. IDC MATERIAL:PC UL94V0 TERMINAL: PHOSPHOR BRONZE, TIN PLATING
3. RJ45 Contact Life:750 Times Min
4. Plug inforce:<30N
5. Solid cable:1/22AWG(0.65MM)-1/24AWG(0.45MM) ID:0.8MM-1.6MM
6. Cable OD:5.0mm-8.5mm
7. PoE per IEEE 802.3af,PoE+per IEEE 802.3at

Fluke Test:Permanent Link ISO 11801 (PL 2)Class Ea
 RoHS 3.0 and REACH Compliant
 Packing:1pc+copper foil/PE bag+label

MATERIAL LIST:

⑦	IDC TERMINAL	FOR 22-24AWG (0.45mm-0.65mm) CABLE	1	
⑥	LABEL COLOR CODE	T568A/B	2	
⑤	IDC PIN	PHOSPHOR BRONZE & TINNED	8	
④	IDC BODY	FIREPROOF/PC UL 94V0	1	
③	PCB	1.2mm UL 94V0	1	
②	RJ-45 JACK INSERT	PHOSPHOR BRONZE 8P8C GOLD PLATED	8	
①	MODULAR COVER	ZINC ALLOY	1	
NO.	PARTS NAME	SPECIFICATION DESCRIPTION	QT'Y	REMARK
		NEW	2022-09-30	A
BY	CHK	REVISION RECORD MODIFICATIONS	DATE	REV.

SYNERGY21

CUSTOMER		ITEM NO.		S216380	
PRODUCT NAME		manufacture country:		CHINA	UNIT
CAT. 6A FTP KEYSTONE JACK					MM
DRAWNBY		CHECKBY		APPOBY	
SYNERGY21		SYNERGY21		SYNERGY21	
				DATE	
				2022-09-30	

Installationsanleitung/Installation guide

Keystone Jack

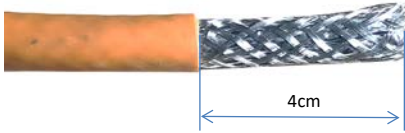

①.Stripping 4cm of sheath.



②.foldback braided and drained wire.



③.paste copper foil on the braided and ground wire and cut off the excess weave and the ground wire

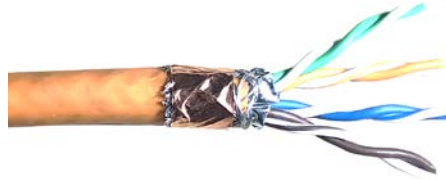

④.4.Fan out all four twisted pairs, allocate each by following colorcoding label



⑤.Across the holde by the color marks of T568A or T568B

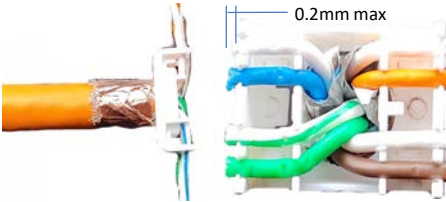

⑥. allocate each conductor into proper slots on wiring cap by following color coding



⑦.Trim the theends of conductors.

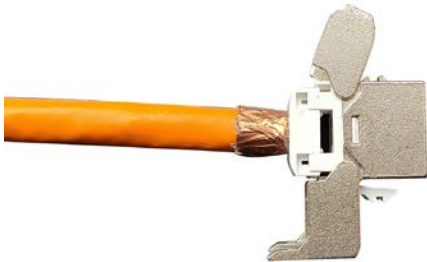

⑧.install the termination cap in direction of arrow into the keystone jack



⑨.press both covers of the keystone jack to contact the cable



⑩.Press down the retainer for 360 degree shielding