

PR750ELCD/PR1000ELCD  
PR1500ELCD

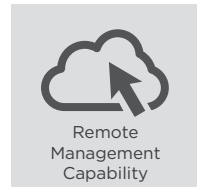

## PROFESSIONAL UPS TO SAFEGUARD IT EQUIPMENT

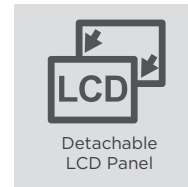
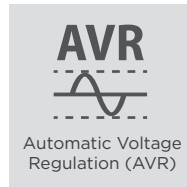
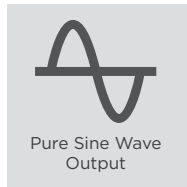
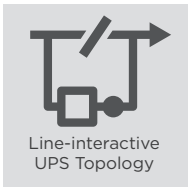

### The professional UPS with Automatic Voltage Regulation to stabilize the AC power output for business applications

Designed for computer room and server room applications, the Professional Tower Series adopts line-interactive topology with Automatic Voltage Regulation (AVR) function to offer stabilized AC power output with Pure Sine Wave to ensure high power quality. The UPSs feature hot-swappable battery packs for maintenance without power interruption. The products are also compatible with power management software to easily control and monitor the UPS system.

#### APPLICATION

- SOHO Office
- Back Office
- Data Center
- Factory
- Train Station
- Office
- Server Room
- Supermarket
- Airport

#### SERIES FEATURES

- Line-interactive UPS Topology
- Active PFC Compatible
- Automatic Voltage Regulation (AVR)
- Hot-swappable Batteries
- Emergency Power Off (EPO) Port
- SNMP/HTTP Remote Management Capability (Optional)
- Energy Saving Technology
- Pure Sine Wave Output
- Critical/Non-critical Load Outlets\*
- Detachable LCD Panel
- PowerPanel® Management Software

\*Selected Model(s)

#### PRODUCT CALLOUTS

- 1 . Power On Indicator
- 2 . Power On/Off Switch
- 3 . LCD Display Panel
- 4 . Function Button(s)
- 5 . Battery Backup & Surge Protected Outlets
- 6 . Input Circuit Breaker
- 7 . AC Inlet
- 8 . Serial Port
- 9 . USB Port
- 10 . SNMP/HTTP Network Slot
- 11 . EPO Port

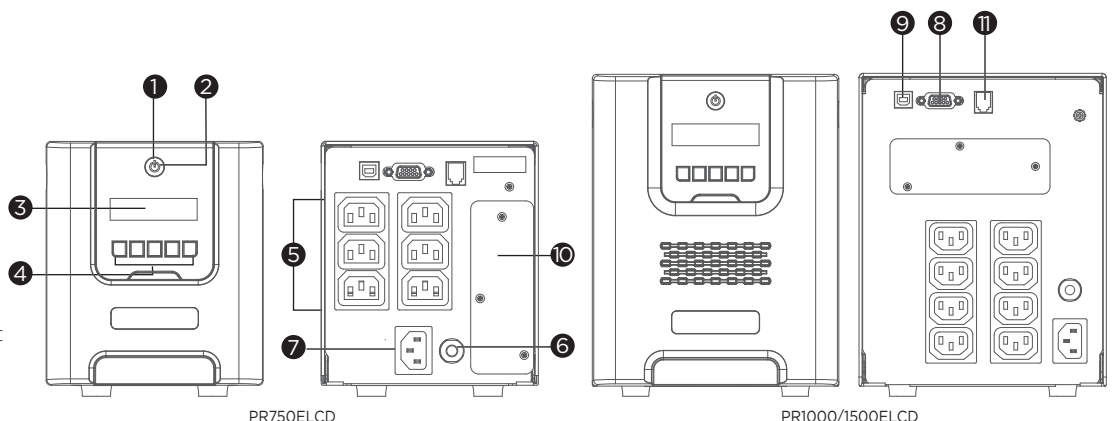



## TECHNICAL SPECIFICATIONS

Model Name	PR750ELCD	PR1000ELCD	PR1500ELCD
<b>General</b>			
UPS Topology	Line-interactive	Line-interactive	Line-interactive
Energy Saving Technology	GreenPower UPS™ Bypass Technology	GreenPower UPS™ Bypass Technology	GreenPower UPS™ Bypass Technology
Active PFC Compatibility	Yes	Yes	Yes
<b>Input</b>			
Nominal Input Voltage (Vac)	230	230	230
Input Voltage Range (Vac)	151 - 301	151 - 301	151 - 301
Input Frequency (Hz)	50 ± 3, 60 ± 3	50 ± 3, 60 ± 3	50 ± 3, 60 ± 3
Input Frequency Detection	Auto-sensing	Auto-sensing	Auto-sensing
Rated Input Current (A)	10	10	10
Input Connector Type	IEC C14	IEC C14	IEC C14
<b>Output</b>			
Capacity (VA)	750	1000	1500
Capacity (Watts)	675	900	1350
On Battery Waveform	Pure Sine Wave	Pure Sine Wave	Pure Sine Wave
On Battery Voltage(s) (Vac)	230 ± 5%	230 ± 5%	230 ± 5%
On Battery Frequency (Hz)	50 ± 1%, 60 ± 1%	50 ± 1%, 60 ± 1%	50 ± 1%, 60 ± 1%
Power Factor	0.9	0.9	0.9
Automatic Voltage Regulation (AVR)	Double Boost, Single Buck	Double Boost, Single Buck	Double Boost, Single Buck
Overload Protection	Internal Current Limiting	Internal Current Limiting	Internal Current Limiting
Outlet(s) - Total	6	8	8
Outlet Type	IEC C13 x 6	IEC C13 x 8	IEC C13 x 8
Outlet(s) - Battery & Surge Protected	6	8	8
Outlet(s) - Critical Load (CL)	-	4	4
Outlet(s) - Non-Critical Load (NCL)	-	4	4
Typical Transfer Time (ms)	4	4	4
<b>Battery</b>			
Runtime at Half Load (min)	12	16	17
Runtime at Full Load (min)	4	4	4
Typical Recharge Time (Hours)	8	8	8
User Replaceable	Yes	Yes	Yes
Hot-Swappable	Yes	Yes	Yes
Battery Type	Sealed Lead-acid	Sealed Lead-acid	Sealed Lead-acid
Replacement Battery Pack	RBP0014	RBP0106	RBP0023
RBP Quantity (pcs)	1	1	1
<b>Surge Protection &amp; Filtering</b>			
Surge Suppression (Joules)	405	405	405
EMI/RFI Filtration	Yes	Yes	Yes
<b>Management &amp; Communications</b>			
LCD Panel	Yes	Yes	Yes
Detachable LCD Panel	Yes	Yes	Yes
HID Compliant USB Port(s)	1	1	1
Serial Port	Combo (RS232 + Dry Contact)	Combo (RS232 + Dry Contact)	Combo (RS232 + Dry Contact)
Emergency Power Off (EPO) Port	Yes	Yes	Yes
Power Management Software	PowerPanel® Business Edition	PowerPanel® Business Edition	PowerPanel® Business Edition
SNMP/HTTP Remote Monitoring	Yes - with optional RMCARD205	Yes - with optional RMCARD205	Yes - with optional RMCARD205
<b>Physical</b>			
Form Factor	Tower	Tower	Tower
<b>Physical Size - UPS Module</b>			
Dimensions (WxHxD) (mm.)	136 x 162 x 349	170 x 221 x 432	170 x 221 x 432
Weight (kg.)	12.3	18.9	25.1
<b>Environmental</b>			
Operating Temperature (°C)	0 - 40	0 - 40	0 - 40
Operating Relative Humidity (Non-condensing) (%)	0 - 95	0 - 95	0 - 95
Online Thermal Dissipation (BTU/hr)	75	102	113
<b>Certifications</b>			
Certifications*	CE, EAC, RCM	CE, EAC, RCM	CE, EAC, RCM
RoHS	Yes	Yes	Yes

\*Certifications may vary according to different regions. Visit [www.cyberpower.com](http://www.cyberpower.com) for more information.  
#All specifications are subject to change without notice.



## The SNMP Card allows users to monitor and manage UPS to perform remote management

Ideal for UPS systems, the Remote Management Card Series provides remote and local management solution. It is an add-on component which can be inserted into a UPS expansion port, allowing users to easily monitor and control UPS status via web browsers, command line interface, and PowerPanel® Power Management Software. The cards are plug-and-play design, simple to install into compatible UPS. The RMCARDs' user-friendly interface supports multiple languages, easy firmware upgrade, and remote schedule/shutdown/start-up/reboot of UPS.

### SERIES FEATURES

- Plug-and-play Installation
- User-friendly Web Interface
- Command Line Interface Supported
- Remotely Schedule Shutdown/ Start-up/ Reboot of the UPS
- Automatic Event Notifications
- Multi-language Supported
- User-upgradeable Firmware
- Syslog Supported
- Secure Authentication
- Compatible with ENVIROSENSOR

### PRODUCT CALLOUTS

1. Universal (Serial) Port
2. Ethernet Port
3. Tx/Rx Indicator
4. Link Indicator

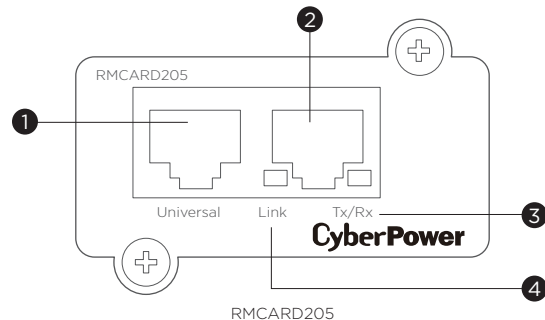

### TECHNICAL SPECIFICATIONS

Model Name	RMCARD205
<b>Management &amp; Communications</b>	
LED Indicators	Tx/Rx, Link
Connectivity Port	RJ45, RJ45 (for Environmental Sensor)
Data Link Protocol	Ethernet 100Base-TX, Ethernet 10Base-T
Support Plug-and-Play Installation	Yes
Power Management Software	PowerPanel® Business (Recommended for small-medium scale management), PowerPanel® Enterprise (Recommended for large scale management)
User-upgradeable Firmware	Yes
Remote Management	Web Browser, Command Line Interface, NMS
Local Management	Web Interface, Command Line Interface
Event Notifications	E-mail, SNMP Traps, Syslog, SMS
Supported Protocols	IPv4/v6, SNMPv1/v3, HTTP/HTTPS, TCP/IP, UDP, DHCP, NTP, DNS, SMTP, SSH, SSL, TLS, Telnet, FTP, and Syslog
Authentication	RADIUS, LDAP, LDAPS, Windows AD
Multi-language Supported	Chinese (Traditional), Chinese (Simplified), English, French, German, Spanish
Environmental Sensor Supported	Yes
<b>Physical</b>	
Dimensions (WxHxD) (mm.)	54 x 36.1 x 76.5
Weight (g.)	38
<b>Certifications</b>	
Certifications*	CE, FCC Class A, EAC
Cisco Compatibility	Yes
RoHS	Yes

\*Certifications may vary according to different regions. Visit [www.cyberpower.com](http://www.cyberpower.com) for more information.  
#All specifications are subject to change without notice.