



CE EMC TEST REPORT

For
ALLNET GmbH

Product Name:	Surge Arrester
Trademark:	N/A
Model Number:	ALL95101
Prepared For :	ALLNET GmbH
Address:	Maistrasse 2 - D-82110 Germering
Prepared By :	Shenzhen BCTC Technology Co., Ltd.
Address:	A. Floor 3, 44 Building, Tanglang Industrial Park B, Taoyuan Street, Nanshan District, Shenzhen, China
Test Date:	Mar. 25 - Apr. 01, 2015
Date of Report :	Apr. 01, 2015
Report No.:	BCTC-150403196



TABLE OF CONTENT

Test Report Declaration	Page
1. GENERAL INFORMATION	6
1.1 Description of Device (EUT)	6
1.2 Test Facility	6
1.3 Tested System Details	6
1.4 Test Uncertainty	7
2. TEST INSTRUMENT USED.....	8
2.1 For Conducted Emission Test	8
2.2 For Radiated Emission Test.....	8
2.3 For Harmonic & Flicker Test	9
2.4 For Electrostatic Discharge Immunity Test	9
2.5 For RF Field Strength Susceptibility Test	9
2.6 For Electrical Fast Transient /Burst Immunity Test	10
2.7 For Surge Test	10
2.8 For Injected Currents Susceptibility Test	10
2.9 For Magnetic Field Immunity Test.....	11
2.10 For Voltage Dips Interruptions Test	11
3. POWER LINE CONDUCTED EMISSION TEST.....	12
3.1 Block Diagram of Test Setup	12
3.2 Test Standard	12
3.3 Power Line Conducted Emission Limit	12
3.4 EUT Configuration on Test	12
3.5 Operating Condition of EUT	13
3.6 Test Procedure	13
3.7 Test Result.....	13
4. RADIATION EMISSION TEST	14
4.1 Block Diagram of Test Setup	14
4.2 Test Standard	14
4.3 Radiation Limit	15
4.4 EUT Configuration on Test	15
4.5 Operating Condition of EUT	15
4.6 Test Procedure	15
4.7 Test Result.....	15
5. HARMONIC CURRENT EMISSION TEST	18
5.1 Block Diagram of Test Setup.....	18
5.2 Test Standard	18
5.3 Operating Condition of EUT	18
5.4 Test Procedure	18
5.5 Test Results.....	18
6. VOLTAGE FLUCTUATIONS & FLICKER TEST	19
6.1 Block Diagram of Test Setup.....	19
6.2 Test Standard	19
6.3 Operating Condition of EUT	19
6.4 Test Results.....	19



7. ELECTROSTATIC DISCHARGE IMMUNITY TEST	20
7.1 Block Diagram of Test Setup	20
7.2 Test Standard	20
7.3 Severity Levels and Performance Criterion	20
7.4 EUT Configuration.....	21
7.5 Operating Condition of EUT.....	21
7.6 Test Procedure.....	21
7.7 Test Results	22
8. RF FIELD STRENGTH SUSCEPTIBILITY TEST	24
8.1 Block Diagram of Test Setup	24
8.2 Test Standard	24
8.3 Severity Levels and Performance Criterion	25
8.4 Operating Condition of EUT.....	25
8.5 Test Procedure.....	25
8.6 Test Results	26
9. ELECTRICAL FAST TRANSIENT/BURST IMMUNITY TEST	28
9.1 Block Diagram of EUT Test Setup.....	28
9.2 Test Standard	28
9.3 Severity Levels and Performance Criterion	28
9.4 EUT Configuration on Test	29
9.5 Operating Condition of EUT.....	29
9.6 Test Procedure.....	29
9.7 Test Results	29
10. SURGE TEST	30
10.1 Block Diagram of EUT Test Setup.....	30
10.2 Test Standard	30
10.3 Severity Levels and Performance Criterion	30
10.4 EUT Configuration on Test	30
10.5 Operating Condition of EUT.....	31
10.6 Test Procedure.....	31
10.7 Test Result.....	31
11. INJECTED CURRENTS SUSCEPTIBILITY TEST	32
11.1 Block Diagram of EUT Test Setup.....	32
11.2 Test Standard	32
11.3 Severity Levels and Performance Criterion	32
11.4 EUT Configuration on Test	33
11.5 Operating Condition of EUT	33
11.6 Test Procedure	33
11.7 Test Result	34
12. MAGNETIC FIELD IMMUNITY TEST	35
12.1 Block Diagram of Test Setup	35
12.2 Test Standard	35
12.3 Severity Levels and Performance Criterion	35
12.4 EUT Configuration on Test	36
12.5 Operating Condition of EUT.....	36
12.6 Test Procedure.....	36
12.7 Test Results	36
13. VOLTAGE DIPS AND INTERRUPTIONS TEST	37
13.1 Block Diagram of EUT Test Setup.....	37
13.2 Test Standard	37
13.3 Severity Levels and Performance Criterion	37



13.4 EUT Configuration on Test	38
13.5 Operating Condition of EUT.....	38
13.6 Test Procedure.....	38
13.7 Test Result.....	38
14. EUT PHOTOGRAPHS	39
15. EUT TEST PHOTOGRAPHS	41



TEST REPORT DECLARATION

Applicant : **ALLNET GmbH**
: Maistrasse 2 - D-82110 Germering
Manufacturer : **ALLNET GmbH**
: Maistrasse 2 - D-82110 Germering
EUT : **Surge Arrester**
Model Number : **ALL95101**
Rating(s) : DC90V===

Test Procedure Used:

EMI : EN 55022 : 2010
EN 61000-3-2 :2014, EN 61000-3-3 :2013
EMS : EN 55024 : 2010
EN 61000-4-2 :2009, EN 61000-4-3 :2006+A1:2008+A2:2010,
EN 61000-4-4 :2012, EN 61000-4-5 :2014,
EN 61000-4-6 :2014, EN 61000-4-8 :2010, EN 61000-4-11 :2004

The device described above is tested by Shenzhen BCTC Technology Co., Ltd. to determine the maximum emission levels emanating from the device, the severe levels which the device can endure and EUT is performance criterion. The test results are contained in this test report. Shenzhen BCTC Technology Co., Ltd. is assumed of full responsibility for the accuracy and completeness of these tests. Also, this report shows that the EUT is technically compliant with the EN55022, EN61000-3-2, EN61000-3-3 and EN55024.

This report applies to above tested sample only and shall not be reproduced in part without written approval of Shenzhen BCTC Technology Co., Ltd.

Date of Test: Mar. 25 - Apr. 01, 2015 -----

Prepared by(Engineer): Snowy Yang -----

Reviewer(Quality Manager): Sophie Lee -----

Approved & Authorized Signer(Manager): Casey Wang -----





1. GENERAL INFORMATION

1.1 Description of Device (EUT)

EUT : **Surge Arrester**
Model Number : **ALL95101**
Power Supply : DC90V===
Applicant : **ALLNET GmbH**
Address : Maistrasse 2 - D-82110 Germering
Manufacturer : **ALLNET GmbH**
Address : Maistrasse 2 - D-82110 Germering
Date of report : **Apr. 01, 2015**
Date of Test : **Mar. 25 - Apr. 01, 2015**

1.2 Test Facility

Site Description
Name of Firm : Shenzhen BCTC Technology Co., Ltd.
Site Location : A. Floor 3, 44 Building, Tanglang Industrial Park B,
Taoyuan Street, Nanshan District, Shenzhen, China

1.3 Tested System Details

Host Personal Computer:	HP	Monitor	: SONY
M/N	: A1580TW	M/N	: MNT1
Printer	: EPSON STYLUS	Keyboard (USB)	: Genuine
M/N	: P320A	M/N	: N/A
Modem	: ACEEX	Mouse	: DETROIS
M/N	: DM-1414	M/N	: CM309



1.4 Test Uncertainty

Conducted Emission Uncertainty : $\pm 2.66\text{dB}$

Radiated Emission Uncertainty : $\pm 4.26\text{dB}$



2. TEST INSTRUMENT USED

2.1 For Conducted Emission Test

Conducted Emission Test (A --- site)					
Equipment	Manufacturer	Model#	Serial#	Last Cal.	Next Cal.
EMI Receiver	Rohde & Schwarz	ESHS30	828985/018	Aug. 25, 2014	Aug. 24, 2015
LISN	Kyoritsu	KNW407	8-1789-4	Aug. 25, 2014	Aug. 24, 2015
Spectrum Analyzer	ADVANTENT	R3132	160400093	Aug. 25, 2014	Aug. 24, 2015
50Ω coaxial switch	Anritsu	MP59B	6200264417	Aug. 25, 2014	Aug. 24, 2015
Pulse Limiter	R&S	ESH3-Z2	100681	Aug. 25, 2014	Aug. 24, 2015

2.2 For Radiated Emission Test

Radiation Emission Test (966 chamber)					
Equipment	Manufacturer	Model#	Serial#	Last Cal.	Next Cal.
Spectrum Analyzer	ADVANTENT	R3132	160400005	Aug. 25, 2014	Aug. 24, 2015
Amplifier	Tsj	MLA-10K-B01-27	1205323	Aug. 25, 2014	Aug. 24, 2015
Antenna	Schwarzbeck	VULB9160	9160-3206	Aug. 25, 2014	Aug. 24, 2015
EMI Receiver	Rohde & Schwarz	ESHS30	828985/018	Aug. 25, 2014	Aug. 24, 2015
Signal Generator	HP	8648A	3625U00573	Aug. 25, 2014	Aug. 24, 2015
50Ω coaxial switch	Anritsu	MP59B	6200264416	Aug. 25, 2014	Aug. 24, 2015



2.3 For Harmonic & Flicker Test

For Harmonic / Flicker Test (A --- site)					
Equipment	Manufacturer	Model#	Serial#	Last Cal.	Next Cal.
Harmonic / Flicker Tester	Schaffner	CCN 1000-1	72472	Aug. 25, 2014	Aug. 24, 2015
Power source	Schaffner	NSG 1007-5-208-413	57227	Aug. 25, 2014	Aug. 24, 2015

2.4 For Electrostatic Discharge Immunity Test

For Electrostatic Discharge Immunity Test (A --- site)					
Equipment	Manufacturer	Model#	Serial#	Last Cal.	Next Cal.
ESD Tester	HAEFELY	PSD 1600	H911'292	Aug. 25, 2014	Aug. 24, 2015

2.5 For RF Field Strength Susceptibility Test

For RF Field Strength Susceptibility Test (A --- site)					
Equipment	Manufacturer	Model#	Serial#	Last Cal.	Next Cal.
Signal Generator	HP	8648A	3625U00573	Aug. 25, 2014	Aug. 24, 2015
Amplifier	A&R	500A100	17034	NCR	NCR
Amplifier	A&R	100W/1000M1	17028	NCR	NCR
Audio Analyzer (20Hz~1000K Hz)	Panasonic	2023B	202301/428	Aug. 25, 2014	Aug. 24, 2015
Isotropic Field Probe	A&R	FP2000	16755	Aug. 25, 2014	Aug. 24, 2015
Antenna	EMCO	3108	9507-2534	NCR	NCR
Log-periodic Antenna	A&R	AT1080	16812	NCR	NCR



2.6 For Electrical Fast Transient /Burst Immunity Test

For Electrical Fast Transient/Burst Immunity Test (A --- site)					
Equipment	Manufacturer	Model#	Serial#	Last Cal.	Next Cal.
Burst Tester	HAEFELY	PEFT4010	080981-16	Aug. 25, 2014	Aug. 24, 2015
Coupling Clamp	HAEFELY	IP-4A	147147	Aug. 25, 2014	Aug. 24, 2015

2.7 For Surge Test

For Surge Test (A --- site)					
Equipment	Manufacturer	Model#	Serial#	Last Cal.	Next Cal.
Surge Tester	HAEFELY	PSURGE4.1	080107-04	Aug. 25, 2014	Aug. 24, 2015

2.8 For Injected Currents Susceptibility Test

For Injected Currents Susceptibility Test (A --- site)					
Equipment	Manufacturer	Model#	Serial#	Last Cal.	Next Cal.
Simulator	EMTEST	CWS500C	0900-12	Aug. 25, 2014	Aug. 24, 2015
CDN	EMTEST	CDN-M2	5100100100	Aug. 25, 2014	Aug. 24, 2015
VDN	EMTEST	CDN-M3	0900-11	Aug. 25, 2014	Aug. 24, 2015
Injection Clamp	EMTEST	F-2031-23MM	368	Aug. 25, 2014	Aug. 24, 2015
Attenuator	EMTEST	ATT6	0010222A	Aug. 25, 2014	Aug. 24, 2015



2.9 For Magnetic Field Immunity Test

For Magnetic Field Immunity Test (A --- site)					
Equipment	Manufacturer	Model#	Serial#	Last Cal.	Next Cal.
Magnetic field generator	Schaffner	MFO6501	34299	Aug. 25, 2014	Aug. 24, 2015
Magnetic field loop antenna	Schaffner	INA702	148	Aug. 25, 2014	Aug. 24, 2015
MC2630	EM Test	MC2630	N/A	Aug. 25, 2014	Aug. 24, 2015
Magnetic	Coils EM Test	MS100	0500-19	Aug. 25, 2014	Aug. 24, 2015

2.10 For Voltage Dips Interruptions Test

For Voltage Dips Interruptions Test (A --- site)					
Equipment	Manufacturer	Model#	Serial#	Last Cal.	Next Cal.
Dips Tester	HEAFELY	PLINE 1610	083732-18	Aug. 25, 2014	Aug. 24, 2015

3. POWER LINE CONDUCTED EMISSION TEST

3.1 Block Diagram of Test Setup

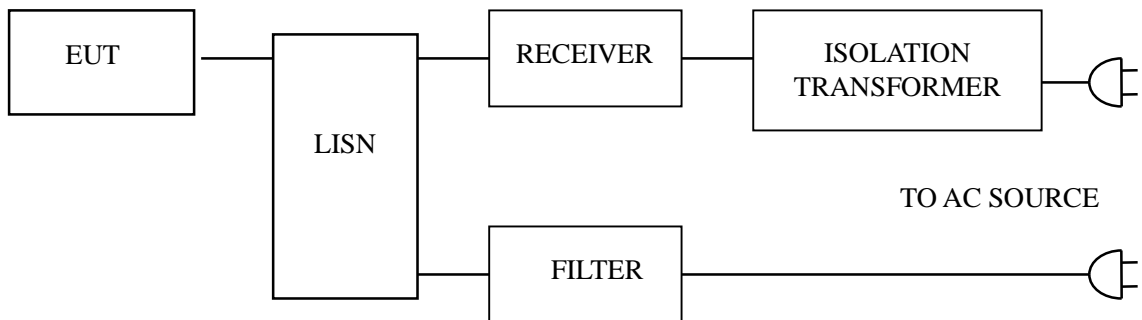

3.2 Test Standard

EN 55022 : 2010

3.3 Power Line Conducted Emission Limit

Frequency MHz	Limits dB(μV)	
	Quasi-peak Level	Average Level
0.15 ~ 0.50	66 ~ 56*	56 ~ 46*
0.50 ~ 5.00	56	46
5.00 ~ 30.00	60	50

Notes: 1. *Decreasing linearly with logarithm of frequency.

2. The lower limit shall apply at the transition frequencies.

3.4 EUT Configuration on Test

The following equipments are installed on conducted emission test to meet EN55022 requirement and operating in a manner which tends to maximize its emission characteristics in a normal application.

3.4.1 Surge Arrester (EUT)

Model Number : **ALL95101**

Manufacturer : **ALLNET GmbH**



3.5 Operating Condition of EUT

- 3.5.1 Setup the EUT and simulators as shown in Section 3.1.
- 3.5.2 Turn on the power of all equipments.
- 3.5.3 Let the EUT work in test modes (On) and test it.

3.6 Test Procedure

The EUT is put on the ground and connected to the AC mains through a Artificial Mains Network (AMN). This provided a 50ohm coupling impedance for the tested equipments. Both sides of AC line are checked to find out the maximum conducted emission levels according to the **EN55022** regulations during conducted emission test.

The bandwidth of the test receiver (R&S Test Receiver ESHS30) is set at 10KHz.

The frequency range from 150 KHz to 30 MHz is investigated.

3.7 Test Result

N/A

4. RADIATION EMISSION TEST

4.1 Block Diagram of Test Setup

4.1.1. Block Diagram of EUT Test Setup

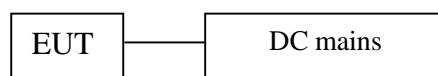

4.1.2. Anechoic Chamber Setup Diagram

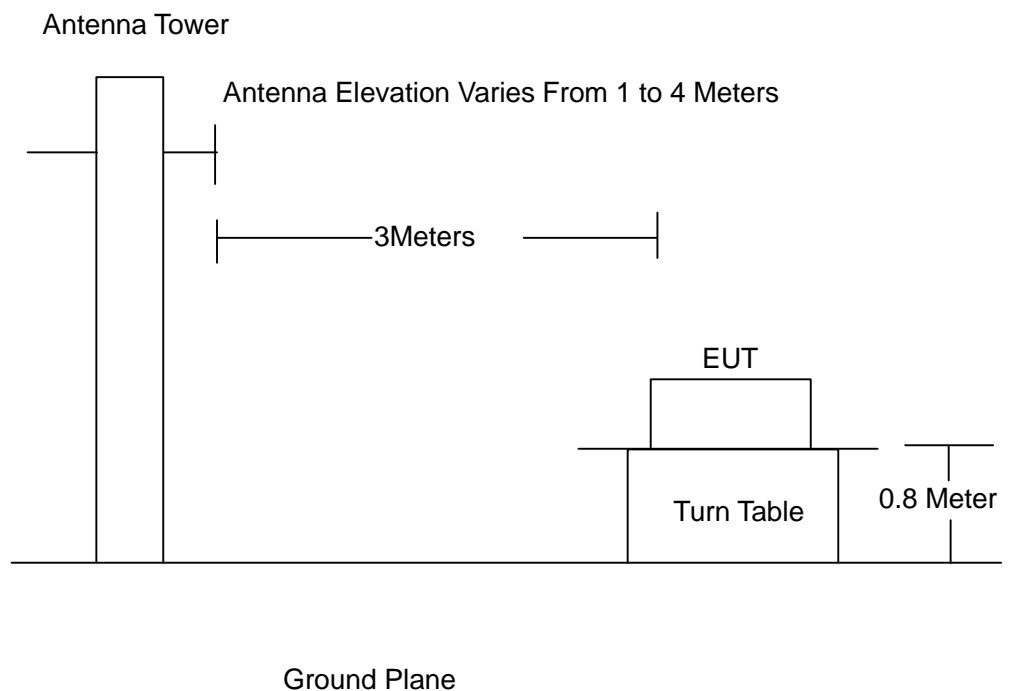

4.2 Test Standard

EN 55022 : 2010



4.3 Radiation Limit

Frequency MHz	Distance (Meters)	Field Strengths Limits dB(μ V)/m
30 ~ 230	3	40.0
230 ~ 1000	3	47.0

Remark:

- (1) Emission level (dB(μ V)/m) = 20 log Emission level (μ V/m)
- (2) The smaller limit shall apply at the cross point between two frequency bands.
- (3) Distance refers to the distance in meters between the measuring instrument, antenna and the closed point of any part of the device or system.

4.4 EUT Configuration on Test

The EN55022 regulations test method must be used to find the maximum emission during radiated emission test.

The configuration of EUT is the same as used in conducted emission test.

Please refer to Section 2.2.

4.5 Operating Condition of EUT

Same as conducted emission test, which is listed in Section 2.2 except the test set up replaced as Section 4.1.

4.6 Test Procedure

The EUT and its simulators are placed on a turned table that is 0.8 meter above the ground. The turned table can rotate 360 degrees to determine the position of the maximum emission level. The EUT is set 3 meters away from the receiving antenna that is mounted on the antenna tower. The antenna can move up and down between 1 meter and 4 meters to find out the maximum emission level. Broadband antenna (calibrated biconical and log periodical antenna) is used as receiving antenna. Both horizontal and vertical polarization of the antenna is set on test. In order to find the maximum emission levels, the interface cable must be manipulated according to EN55022 on radiated emission test.

The bandwidth setting on the field strength meter (R&S Test Receiver ESHS30) is set at 120KHz.

The frequency range from 30MHz to 1000MHz is checked.

4.7 Test Result

PASS

Please refer to the following page.



倍测检测
BCTC TEST

Address1: No. 101, Yousheng Road, Longhua New District,
Shenzhen, Guangdong P.R. China
Tel: 400-788-9558

Radiated Emission Measurement

File :9

Data :#77

Date: 2015/3/30

Time: 18:25:22

80.0 dBuV/m

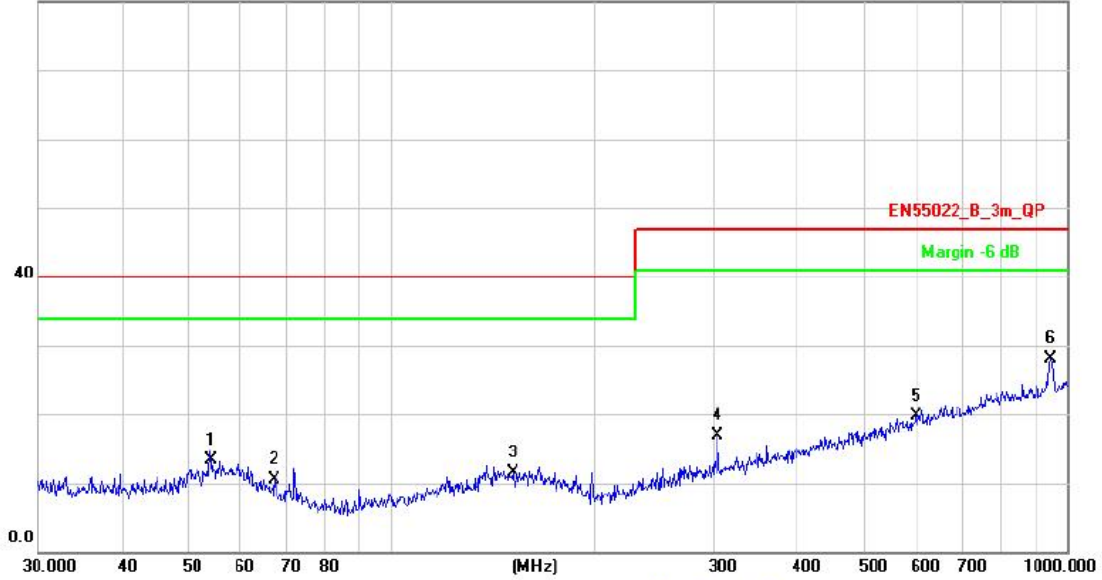

Site 966 BCTC Chamber #1
Limit: EN55022_B_3m_QP
EUT: Surge Arrester
M/N: ALL95101
Mode: Working
Note:

Polarization: **Horizontal**
Power: DC90V
Distance: 3m
Temperature: 26
Humidity: 55 %

No.	Mk.	Freq. MHz	Reading Level dBuV	Correct Factor dB/m	Measure- ment dBuV/m	Limit dBuV/m	Over dB	Detector	Antenna Height cm	Table Degree degree	Comment
1		54.2610	29.05	-15.65	13.40	40.00	-26.60	peak			
2		67.2022	26.73	-16.30	10.43	40.00	-29.57	peak			
3		151.5972	25.25	-13.82	11.43	40.00	-28.57	peak			
4		304.6099	30.09	-13.11	16.98	47.00	-30.02	peak			
5		599.3212	25.60	-5.93	19.67	47.00	-27.33	peak			
6	*	948.7610	28.80	-0.70	28.10	47.00	-18.90	peak			

*:Maximum data x:Over limit !:over margin

5. HARMONIC CURRENT EMISSION TEST

5.1 Block Diagram of Test Setup

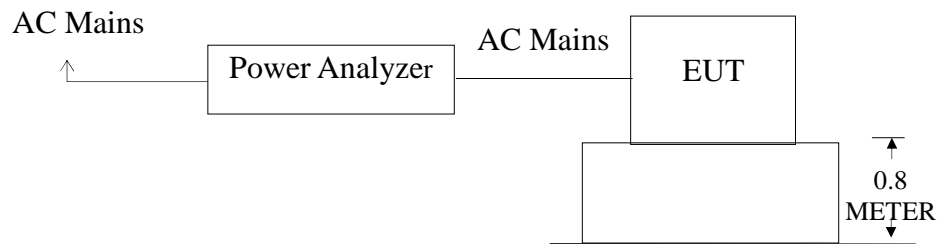

(EUT: **Surge Arrester**)

5.2 Test Standard

EN 61000-3-2:2014

5.3 Operating Condition of EUT

- 5.3.1 Setup the EUT as shown in Section 5.1.
- 5.3.2 Turn on the power of all equipments.
- 5.3.3 Let the EUT work in test mode (ON) and test it.

5.4 Test Procedure

The power cord of the EUT is connected to the output of the test system. Turn on the power of the EUT and use the test system to test the harmonic current level.

5.5 Test Results

N/A



6. VOLTAGE FLUCTUATIONS & FLICKER TEST

6.1 Block Diagram of Test Setup

Same as Section 5.1..

6.2 Test Standard

EN 61000-3-3:2013

6.3 Operating Condition of EUT

Same as Section 5.3.. The power cord of the EUT is connected to the output of the test system. Turn on the power of the EUT and use the test system to test the harmonic current level.

Flicker Test Limit

Test items	Limits
Pst	1.0
dc	3.3%
dmax	4.0%
dt	Not exceed 3.3% for 500ms

6.4 Test Results

N/A

7. ELECTROSTATIC DISCHARGE IMMUNITY TEST

7.1 Block Diagram of Test Setup

7.1.1. Block Diagram of the EUT and the simulators

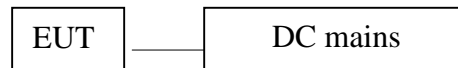

7.1.2. Test Setup

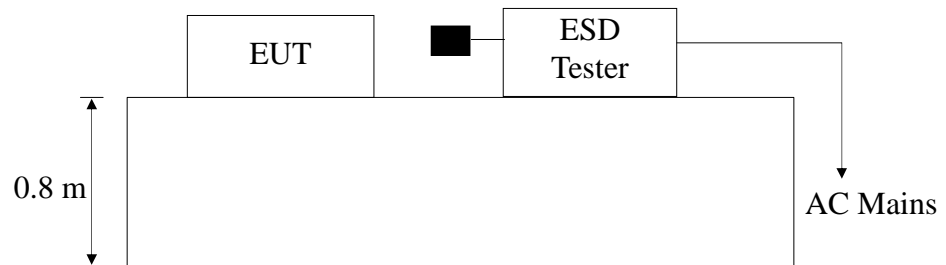

7.2 Test Standard

EN 55024:2010, EN 61000-4-2:2009

Severity Level: 3 / Air Discharge: $\pm 8\text{KV}$

Level: 2 / Contact Discharge: $\pm 4\text{KV}$

7.3 Severity Levels and Performance Criterion

7.3.1 Severity level

Level	Test Voltage Contact Discharge (KV)	Test Voltage Air Discharge (KV)
1.	± 2	± 2
2.	± 4	± 4
3.	± 6	± 8
4.	± 8	± 15
X	Special	Special



7.3.2 Performance criterion : B

- A.** The apparatus shall continue to operate as intended during and after the test. No degradation of performance or loss of function is allowed below a performance level specified by the manufacturer, when the apparatus is used as intended.

- B.** The apparatus shall continue to operate as intended after the test. No degradation of performance or loss of function is allowed below a performance level specified by the manufacturer, when the apparatus is used as intended. The performance level may be replaced by a permissible loss of performance. During the test, degradation of performance is however allowed.

- C.** Temporary loss of function is allowed, provided the function is self-recoverable or can be restored by the operation of the controls.

7.4 EUT Configuration

The following equipments are installed on Electrostatic Discharge Immunity test to meet EN 55024:2010, EN 61000-4-2:2009, requirement and operating in a manner which tends to maximize its emission characteristics in a normal application. The configuration of EUT is the same as used in conducted emission test. Please refer to Section 2.4.

7.5 Operating Condition of EUT

Same as conducted emission measurement, which is listed in Section 3.5 except the test setup replaced by Section 7.1.2.

7.6 Test Procedure

7.6.1 Air Discharge:

This test is done on a non-conductive surface. The round discharge tip of the discharge electrode shall be approached as fast as possible to touch the EUT. After each discharge, the discharge electrode shall be removed from the EUT. The generator is then re-triggered for a new single discharge and repeated 10 times for each pre-selected test point. This procedure shall be repeated until all the air discharge completed.

7.6.2 Contact Discharge:

All the procedure shall be same as Section 7.6.1. Except that the tip of the discharge electrode shall touch the EUT before the discharge switch is operated.



7.6.3 Indirect discharge for horizontal coupling plane

At least 10 single discharges (in the most sensitive polarity) shall be applied at the front edge of each HCP opposite the center point of each unit (if applicable) of the EUT and 0.1m from the front of the EUT. The long axis of the discharge electrode shall be in the plane of the HCP and perpendicular to its front edge during the discharge.

7.6.4 Indirect discharge for vertical coupling plane

At least 10 single discharges (in the most sensitive polarity) shall be applied to the center of one vertical edge of the coupling plane. The coupling plane, of dimensions 0.5m X 0.5m, is placed parallel to, and positioned at a distance of 0.1m from the EUT. Discharges shall be applied to the coupling plane, with this plane in sufficient different positions that the four faces of the EUT are complete illuminated.

7.7 Test Results

PASS

Please refer to the following page.



Electrostatic Discharge Test Results

Shenzhen BCTC Technology Co., Ltd.

Applicant	: ALLNET GmbH	Test Date	: Apr. 01, 2015	
EUT	: Surge Arrester	Temperature:	25°C	
M/N	: ALL95101	Humidity	: 53%	
Power Supply	: DC90V			
Test Engineer	: Snowy Yang			
Air Discharge: ± 2,4,8KV				
Contact Discharge: ± 2,4KV # For each point positive 25 times and negative 25 times discharge				
Test Points	Air Discharge	Contact Discharge	Performance Criterion	Result
Others Slot of the EUT	±2,4,8KV	N/A	B	PASS
COVER	N/A	±2,4 KV	B	PASS
SCREW	N/A	±2,4 KV	B	PASS
VCP	N/A	±2,4 KV	B	PASS
HCP	N/A	±2,4 KV	B	PASS

8. RF FIELD STRENGTH SUSCEPTIBILITY TEST

8.1 Block Diagram of Test Setup

8.1.1. Block Diagram of the EUT and the simulators

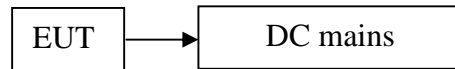

8.1.2. R/S Test Setup

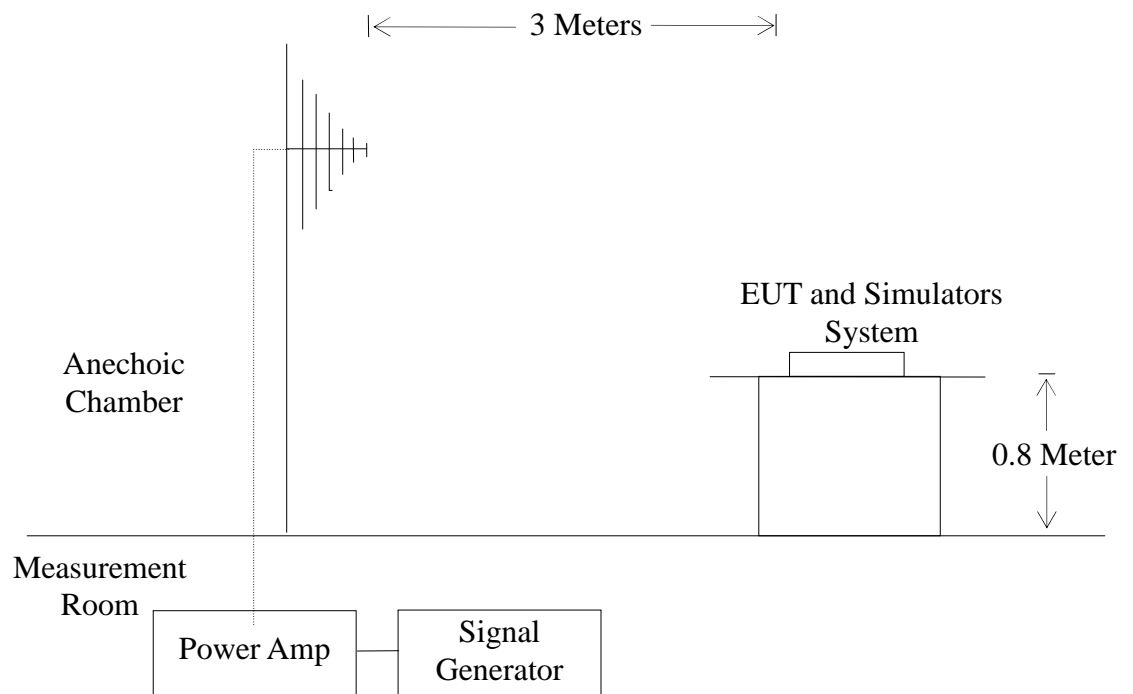

8.2 Test Standard

EN 55024:2010, EN 61000-4-3: 2006+A1:2008+A2:2010
Severity Level 2, 3V / m



8.3 Severity Levels and Performance Criterion

8.3.1. Severity level

Level	Field Strength V/m
1.	1
2.	3
3.	10
X.	Special

8.3.2. Performance criterion: A

- A、 The apparatus shall continue to operate as intended during and after the test. No degradation of performance or loss of function is allowed below a performance level specified by the manufacturer, when the apparatus is used as intended.
- B、 The apparatus shall continue to operate as intended after the test. No degradation of performance or loss of function is allowed below a performance level specified by the manufacturer, when the apparatus is used as intended. The performance level may be replaced by a permissible loss of performance. During the test, degradation of performance is however allowed.
- C、 Temporary loss of function is allowed, provided the function is self-recoverable or can be restored by the operation of the controls.

8.4 Operating Condition of EUT

Same as conducted emission measurement, which is listed in Section 2.5 except the test setup replaced by Section 8.1.

8.5 Test Procedure

The EUT and its simulators are placed on a turn table which is 0.8 meter above ground. EUT is set 3 meter away from the transmitting antenna which is mounted on an antenna tower. Both horizontal and vertical polarization of the antenna are set on test. Each of the four sides of EUT must be faced this transmitting antenna and measured individually.



All the scanning conditions are as follows :

Condition of Test	Remarks
-----	-----
1. Fielded Strength	3 V/m (Severity Level 2)
2. Radiated Signal	Modulated
3. Scanning Frequency	80 – 1000 MHz
4. Dwell time of radiated	0.0015 decade/s
5. Waiting Time	1 Sec.

8.6 Test Results

PASS

Please refer to the following page.



RF Field Strength Susceptibility Test Results

Shenzhen BCTC Technology Co., Ltd.

Applicant: ALLNET GmbH		Test Date : Apr. 01, 2015	
EUT : Surge Arrester		Temperature : 25°C	
M/N : ALL95101		Humidity : 53%	
Field Strength: 3 V/m		Criterion: A	
Power Supply: DC90V		Frequency Range: 80 MHz to 1000 MHz	
Test Engineer: Snowy Yang			
Modulation: p AM .. Pulse .. none 1 KHz 80%			
Test Mode : On			
	Frequency Range : 80-1000MHz		
Steps	1 %		
	Horizontal	Vertical	Result
Front	A	A	Pass
Right	A	A	Pass
Rear	A	A	Pass
Left	A	A	Pass

9. ELECTRICAL FAST TRANSIENT/BURST IMMUNITY TEST

9.1 Block Diagram of EUT Test Setup

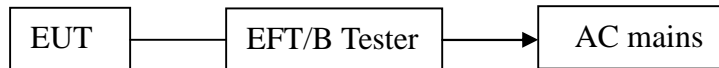

9.2 Test Standard

EN 55024:2010, EN 61000-4-4:2012

9.3 Severity Levels and Performance Criterion

Severity Level 2 at 1KV, Pulse Rise time & Duration: 5 nS / 50 nS

Severity Level:

Open Circuit Output Test Voltage $\pm 10\%$		
Level	On power ports	On I/O(Input/Output) Signal data and control ports
1.	0.5KV	0.25KV
2.	1KV	0.5KV
3.	2KV	1KV
4.	4KV	2KV
X.	Special	Special

Performance criterion: B

- A. The apparatus shall continue to operate as intended during and after the test. No degradation of performance or loss of function is allowed below a performance level specified by the manufacturer, when the apparatus is used as intended.
- B. The apparatus shall continue to operate as intended after the test. No degradation of performance or loss of function is allowed below a performance level specified by the manufacturer, when the apparatus is used as intended. The performance level may be replaced by a permissible loss of performance. During the test, degradation of performance is however allowed.
- C. Temporary loss of function is allowed, provided the function is self-recoverable or can be restored by the operation of the controls.



9.4 EUT Configuration on Test

The following equipments are installed on Electrical Fast Transient/Burst Immunity test to meet EN 55024:2010, EN 61000-4-4:2012, requirement and operating in a manner which tends to maximize its emission characteristics in a normal application. The configuration of EUT is the same as used in conducted emission test.

Please refer to Section 3.4.

9.5 Operating Condition of EUT

Same as conducted emission measurement, which is listed in Section 2.6 except the test setup replaced by Section 9.1.

9.6 Test Procedure

EUT shall be placed 0.8m high above the ground reference plane which is a min.1m*1m metallic sheet with 0.65mm minimum thickness. This reference ground plane shall project beyond the EUT by at least 0.1m on all sides and the minimum distance between EUT and all other conductive structure, except the ground plane beneath the EUT, shall be more than 0.5m

9.6.1. For input and output AC power ports:

The EUT is connected to the power mains by using a coupling device which couples the EFT interference signal to AC power lines. Both polarities of the test voltage should be applied during compliance test and the duration of the test is 2 minutes.

9.6.2. For signal lines and control lines ports:

It's unnecessary to measure.

9.6.3. For AC input and DC output power ports:

For DC ports .It's unnecessary to measure

9.7 Test Results

N/A

10. SURGE TEST

10.1 Block Diagram of EUT Test Setup

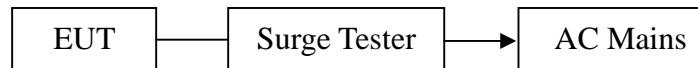

10.2 Test Standard

EN 55024:2010, EN61000-4-5:2014

10.3 Severity Levels and Performance Criterion

Severity Level: Line to Line, Level 2 at 1KV;

Severity Level: Line to Earth, Level 3 at 2KV.

Severity Level	Open-Circuit Test Voltage (KV)
1.	0.5
2.	1.0
3.	2.0
4.	4.0
X.	Special

Performance criterion: B

- A. The apparatus shall continue to operate as intended during and after the test. No degradation of performance or loss of function is allowed below a performance level specified by the manufacturer, when the apparatus is used as intended.
- B. The apparatus shall continue to operate as intended after the test. No degradation of performance or loss of function is allowed below a performance level specified by the manufacturer, when the apparatus is used as intended. The performance level may be replaced by a permissible loss of performance. During the test, degradation of performance is however allowed.
- C. Temporary loss of function is allowed, provided the function is self-recoverable or can be restored by the operation of the controls.

10.4 EUT Configuration on Test

The following equipments are installed on Electrical Fast Transient/Burst Immunity test to meet EN 55024:2010, EN61000-4-5:2014, requirement and



operating in a manner which tends to maximize its emission characteristics in a normal application

The configuration of EUT is the same as used in conducted emission test. Please refer to Section 3.4.

10.5 Operating Condition of EUT

Same as conducted emission measurement, which is listed in Section 2.7 except the test setup replaced by Section 10.1.

10.6 Test Procedure

- 1) Set up the EUT and test generator as shown on section 10.1
- 2) For line to line coupling mode, provide a 1KV 1.2/50us voltage surge (at open-circuit condition) and 8/20us current surge to EUT selected points.
- 3) At least 5 positive and 5 negative (polarity) tests with a maximum 1/min repetition rate are conducted during test.
- 4) Different phase angles are done individually.
- 5) Repeat procedure 2) to 4) except the open-circuit test voltage change from 1KV to 2KV for line to earth coupling mode test.
- 6) Record the EUT operating situation during compliance test and decide the EUT immunity criterion for above each test.

10.7 Test Result

N/A

11. INJECTED CURRENTS SUSCEPTIBILITY TEST

11.1 Block Diagram of EUT Test Setup

11.1.1. Block Diagram of EUT Test Setup

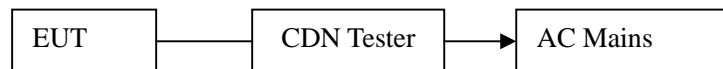

11.1.2. Block Diagram of Test Setup

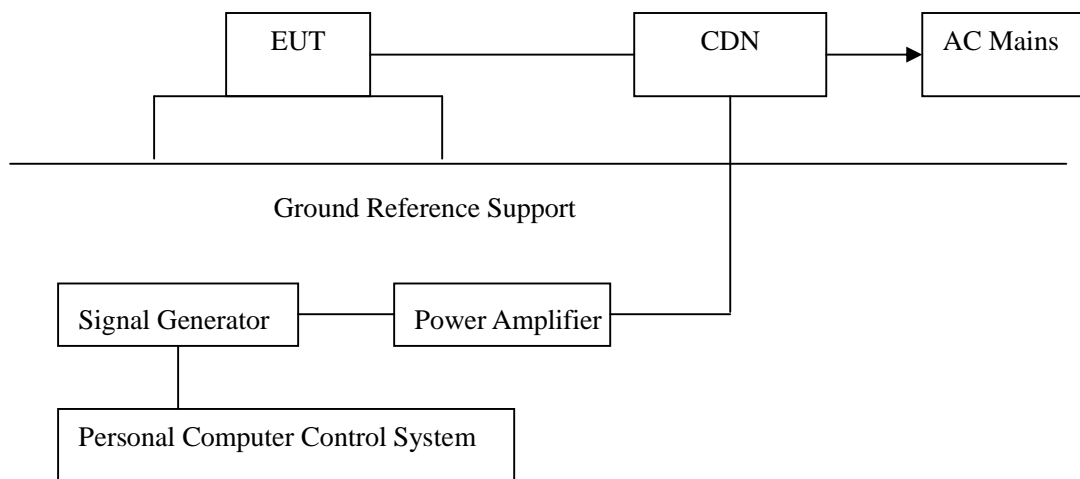

11.2 Test Standard

EN 55024:2010, EN61000-4-6:2014

11.3 Severity Levels and Performance Criterion

Severity Level 2: 3V(rms), 150KHz ~ 80MHz

Severity Level:

Level	Field Strength V
1.	1
2.	3
3.	10
X.	Special



Performance criterion: A

- A. The apparatus shall continue to operate as intended during and after the test. No degradation of performance or loss of function is allowed below a performance level specified by the manufacturer, when the apparatus is used as intended.
- B. The apparatus shall continue to operate as intended after the test. No degradation of performance or loss of function is allowed below a performance level specified by the manufacturer, when the apparatus is used as intended. The performance level may be replaced by a permissible loss of performance. During the test, degradation of performance is however allowed.
- C. Temporary loss of function is allowed, provided the function is self-recoverable or can be restored by the operation of the controls.

11.4 EUT Configuration on Test

The configuration of EUT is the same as used in conducted emission test. Please refer to Section 2.8.

11.5 Operating Condition of EUT

Same as conducted emission test, which is listed in Section 2.8 except the test set up replaced as Section 11.1.

11.6 Test Procedure

- 1) Set up the EUT, CDN and test generator as shown on section 11.1
- 2) Let EUT work in test mode and measure.
- 3) The EUT and supporting equipments are placed on an insulating support 0.1m high above a ground reference plane. CDN (coupling and decoupling device) is placed on the ground plane at above 0.1-0.3m from EUT. Cables between CDN and EUT are as short as possible, and their height above the ground reference plane shall be between 30 and 50 mm (where possible).
- 4) The disturbance signal described below is injected to EUT through CDN.
- 5) The EUT operates within its operational mode(s) under intended climatic conditions after power on.
- 6) The frequency range is swept from 150KHz to 80MHz using 3V signal level, and with the disturbance signal 80% amplitude modulated with a 1KHz sine wave



- 7) The rate of sweep shall not exceed 1.5×10^{-3} decades/s. Where the frequency is swept incrementally, the step size shall not exceed 1% of the start and thereafter 1% of the preceding frequency value.
- 8) Recording the EUT operating situation during compliance test and decide the EUT immunity criterion for above each test.

11.7 Test Result

N/A

12. MAGNETIC FIELD IMMUNITY TEST

12.1 Block Diagram of Test Setup

12.1.1 Block Diagram of the EUT

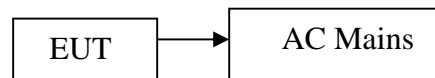

12.1.2 Block Diagram of Test Setup

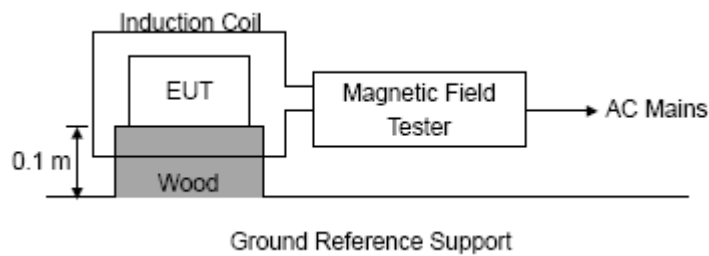

12.2 Test Standard

EN 55024:2010, EN61000-4-8:2010

Severity Level 1 at 1A/m

12.3 Severity Levels and Performance Criterion

12.3.1 Severity level

Level	Magnetic Field Strength A/m
1.	1
2.	3
3.	10
4.	30
5.	100
X.	Special



12.3.2 Performance criterion: B

- A. The apparatus shall continue to operate as intended during and after the test. No degradation of performance or loss of function is allowed below a performance level specified by the manufacturer, when the apparatus is used as intended.
- B. The apparatus shall continue to operate as intended after the test. No degradation of performance or loss of function is allowed below a performance level specified by the manufacturer, when the apparatus is used as intended. The performance level may be replaced by a permissible loss of performance. During the test, degradation of performance is however allowed.
- C. Temporary loss of function is allowed, provided the function is self-recoverable or can be restored by the operation of the controls.

12.4 EUT Configuration on Test

The configuration of EUT is listed in Section 2.9.

12.5 Operating Condition of EUT

Same as conducted emission test, which is listed in Section 2.9 except the test set up replaced as Section 12.1.

12.6 Test Procedure

The EUT shall be subjected to the test magnetic field by using the induction coil of standard dimensions (1m*1m) and shown in Section 10.1. The induction coil shall then be rotated by 90° in order to expose the EUT to the test field with different orientations.

12.7 Test Results

N/A



13. VOLTAGE DIPS AND INTERRUPTIONS TEST

13.1 Block Diagram of EUT Test Setup



13.2 Test Standard

EN 55024:2010, EN61000-4-11:2004

13.3 Severity Levels and Performance Criterion

Severity Level:

Input and Output AC Power Ports.

p Voltage Dips.

p Voltage Interruptions.

Environmental Phenomena	Test Specification	Units	Performance Criterion
Voltage Dips	>95 0.5	% Reduction period	B
	30 25	% Reduction period	C
Voltage Interruptions	>95 250	% Reduction period	C

Performance criterion: B, C, C

- A. The apparatus shall continue to operate as intended during and after the test. No degradation of performance or loss of function is allowed below a performance level specified by the manufacturer, when the apparatus is used as intended.
- B. The apparatus shall continue to operate as intended after the test. No degradation of performance or loss of function is allowed below a performance level specified by the manufacturer, when the apparatus is used



as intended. The performance level may be replaced by a permissible loss of performance. During the test, degradation of performance is however allowed.

- C. Temporary loss of function is allowed, provided the function is self-recoverable or can be restored by the operation of the controls.

13.4 EUT Configuration on Test

The configuration of EUT is the same as used in conducted emission test. Please refer to Section 2.10.

13.5 Operating Condition of EUT

Same as conducted emission test, which is listed in Section 2.10 except the test set up replaced as Section 13.1.

13.6 Test Procedure

- 1) Set up the EUT and test generator as shown on section 13.1
- 2) The interruption is introduced at selected phase angles with specified duration. There is a 3mins minimum interval between each test event.
- 3) After each test a full functional check is performed before the next test.
- 4) Repeat procedures 2 & 3 for voltage dips, only the level and duration is changed.
- 5) Record any degradation of performance.

13.7 Test Result

N/A

14. EUT PHOTOGRAPHS

EUT Photo 1



EUT Photo 2



EUT Photo 3

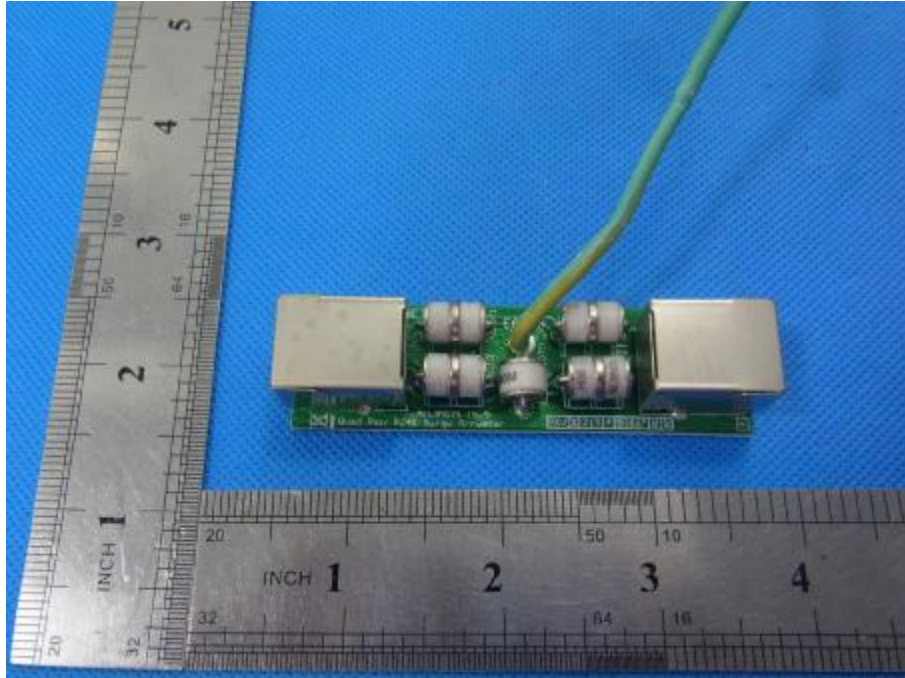

EUT Photo 4

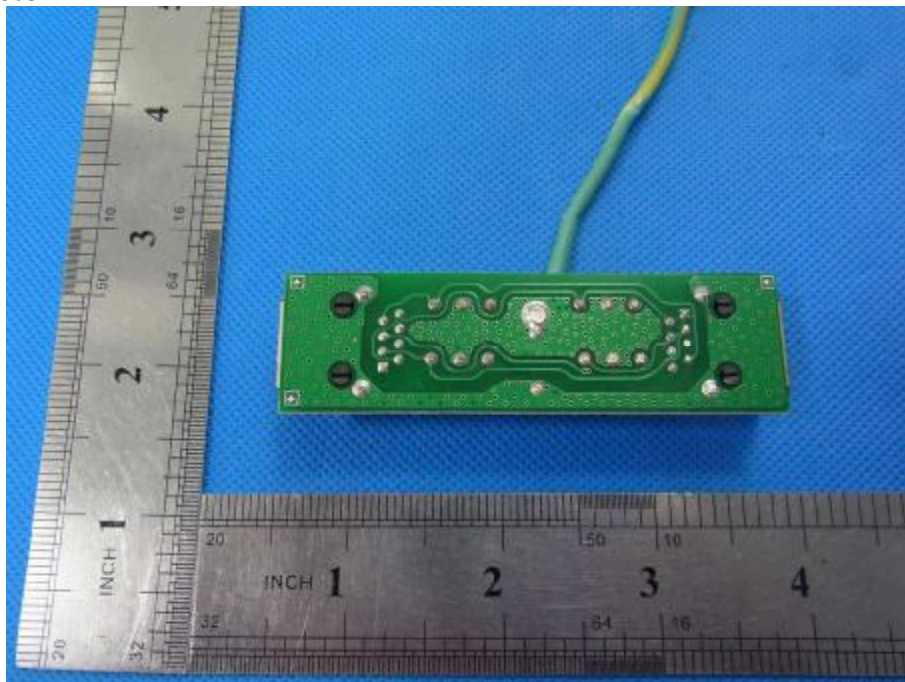



15. EUT TEST PHOTOGRAPHS

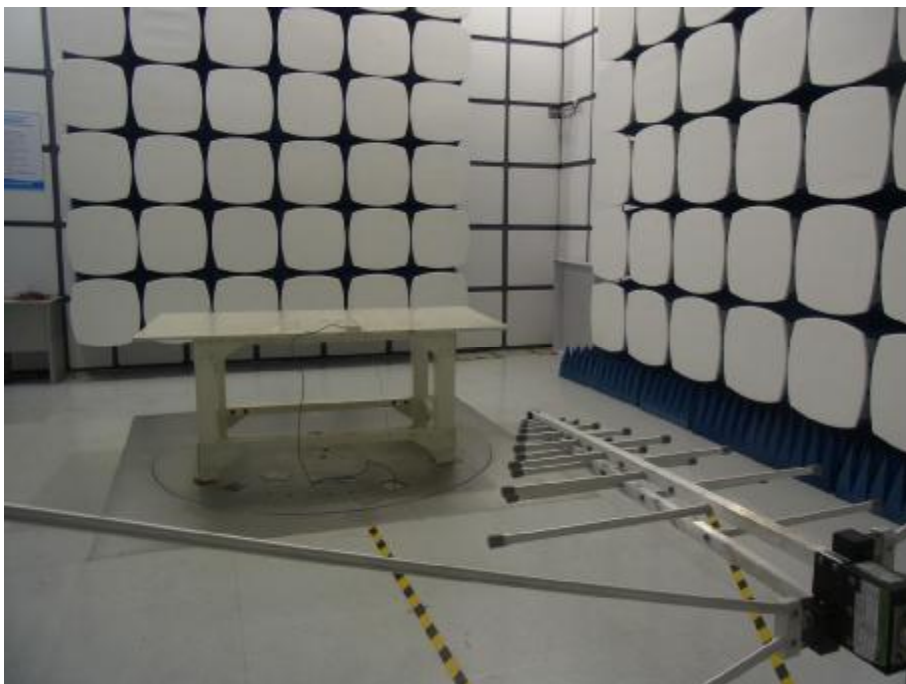

***** END OF REPORT *****