

Synergy 21 LED spot pendant luminaire UFO 120W for industry/warehouses cw 90°



kwh/1000h:	120,00
Lumens:	16000
Watt:	120,0
Nominal Service Life:	50000 Std.
Switching Cycles:	50000
Opt. Ambient Temperature.:	25 °C



AC 90-305V/50-60Hz
Dimmable: no
Power: 120 Watt
Luminous flux: 16000 lm
Efficiency: 135lm/W
Beam angle: 90°
CRI Ra: > 80
Light colour: cool white
Kelvin: 6500K ± 10%
Operating temperature: -40 to +55°C
Protection class: IP65, IK10, "D" labelling according to EN 60598-2-24
Weight: 4.8kg
Diameter: 260mm
Complete height: 177.5mm

Energy efficiency class: A++
kWh/1000h: 120

5 year guarantee
IES files available on request

Attributes

Attribute	Value
Abstrahlwinkel:	90
Betriebstemperatur:	-40 bis +55
CRI:	>80
Dimmbar:	nein
Grösse:	260*177,5
LED - Gehäusefarbe:	schwarz
LED - Gehäusematerial:	Aluminium
Lichtfarbe:	kaltweiß
Lichtfarbe in Kelvin:	6500
Lumen:	16000
Schutzklasse:	IP65/IK10
Volt:	230
Weight:	4.8 Kg
Warranty:	60.00 Months

Additional Images



Dimension



Installation:





Product Description

- 1, Compact and fasion design .Light weighted : 4.80kg
- 2, Philips 3030 LED as light source , CR>80Ra
- 3, MEAN WELL HBG Series power supply . PF>0.95
- 4, High lumen efficiency : 135lm/w
- 5, 5 years warranty .

Performance Summary

Input Power: 80W, 100W, 150W, 200W, 230W
 CRI: >70Ra/80Ra
 CCT: 3000k-6500K
 Input Voltage:90-305Vac
 Limited Warranty :5 years' warranty
 High Efficacy Lifetime: 50000hours
 Dimming:Non-dimmable & 1-10V Dimmable
 Working Temperature : - 20°C – +45 °C(Amb)

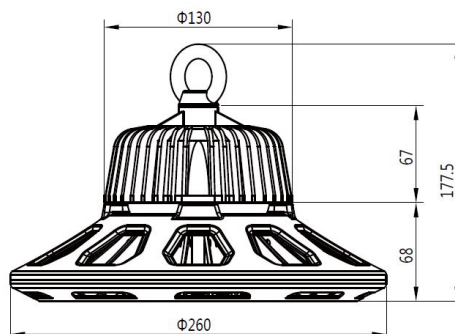

Accessories

Part No.	Name
139691	Synergy 21 LED Spot pendant light UFO add. Radar Kit M
142946	Synergy 21 LED spot pendant light UFO add. Wall bracket for UFO size M bracket long
142945	Synergy 21 LED spot pendant light UFO add. Wall bracket for UFO size M bracket short
144401	Synergy 21 LED spot pendant light UFO add. ball cage M
148950	Synergy 21 LED spot pendant light UFO add. Lampshade M
148726	Synergy 21 - Waterproof connector 1:1

Part No.	Name
148727	Synergy 21 - Waterproof connector 1:2
148730	Synergy 21 - Waterproof connector box 3 ports
148729	Synergy 21 - Waterproof connector box 3 ports transparent
148728	Synergy 21 - Waterproof connector box 4 ports
134899	Synergy 21 Netzteil - Einschaltstrombegrenzer OSRAM
157359	Finder SSR relay (inrush current limiter)
157358	Finder installation contactor 25A (inrush current limiter)
158976	Finder dimmer for top-hat rail Master
158977	Finder dimmer for top-hat rail SLAVE
140646	Synergy 21 LED sensor 0-10V brightness sensor