

ANTENNAS | PANL-41 SERIES

5-IN-1 OMNI-DIRECTIONAL WIDEBAND PANEL 5G ANTENNA

410 – 6000 MHz, 10.5 dBi; 4 x Cellular & 1 x GNSS

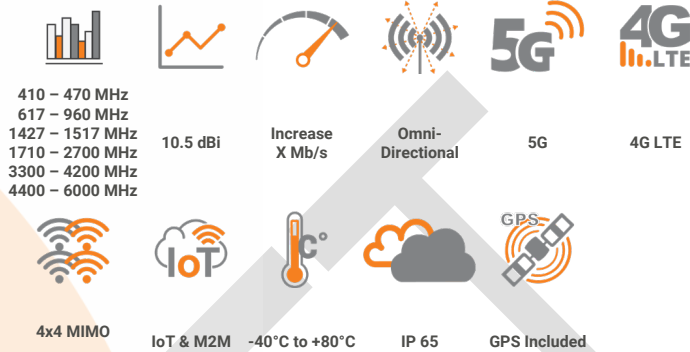
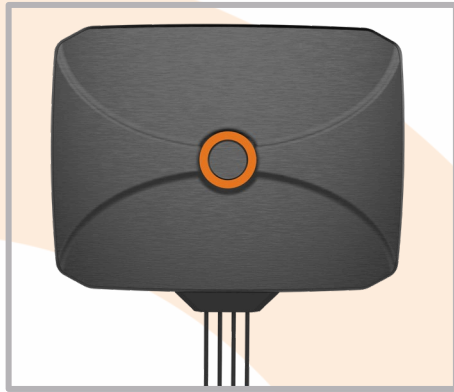

APPLICATION AREAS

- 5-in-1 high-performance multi-functional 5G antenna
- 4 x Cellular and 1 x Dual Band GNSS antennas
- Linear Vertical & Horizontal antennas for improved performance
- Omni-Directional panel antenna with a low-profile design
- Easy installation and versatile form factor
- Weather, dust, and vandal-resistant enclosure (IP65)

Product Overview

Introducing the PANL-41: a state-of-the-art, multi-functional panel antenna designed to revolutionize connectivity. This versatile antenna configuration offers a 5-in-1 solution, including 4 x Cellular and 1 x dual-band active GNSS antenna, which provides exceptional performance and versatility for improving cellular and GPS signal reception in vehicles or fixed installations.

The PANL-41 is an ultra-wideband antenna that covers a broad frequency range from 410 to 6000 MHz. This allows it to be used across different cellular operators and technologies, and it is ready for future cellular technologies up to 6GHz for 5G applications. The antenna provides an excellent balance between omnidirectionality, pattern diversity, and good radiation abilities at the desired elevation, which is an important criterion, especially for the transportation market. Additionally, the inclusion of a dual-band GNSS antenna ensures reliable navigation and precise location tracking, even in challenging environments.

Featuring a low-profile and compact design, the PANL-41 seamlessly blends into any environment, addressing both aesthetic and practical considerations. Its convenient window mount design simplifies installation, allowing for easy attachment to vehicle or building windows through either the included suction cups or adhesive mount.

With exceptional GNSS capabilities and wideband performance, the PANL-41 serves as your gateway to unparalleled connectivity across diverse wireless applications.

Features

- 5-in-1 antenna solution; 4 x Cellular & 1 x Dual Band GNSS
- Ultra-wideband coverage from 410 to 6000 MHz
- 4x4 MIMO linear vertical & horizontal antennas for improved results
- Low-profile and rugged mechanical design with an IP65 rating
- Easy to install with adhesive mounting and suction cup options

Application Areas

- Enhances connectivity for vehicles, trains, and ships, ensuring robust communication and precise GNSS tracking
- Ideal for enhancing cellular connectivity in urban and rural areas supporting 4G/LTE and 5G networks
- Enables seamless communication for smart city infrastructure
- Enhances connectivity for remote monitoring and control of energy infrastructure, such as oil and gas



PANL-41

Frequency Bands

The PANL-41 is a wide-band 5G/4G antenna that works from | 410 – 470 MHz | 617 – 960 MHz | 1427 – 1517 MHz | 1710 – 2700 MHz | 3300 – 4200 MHz | and | 4400 – 6000 MHz |

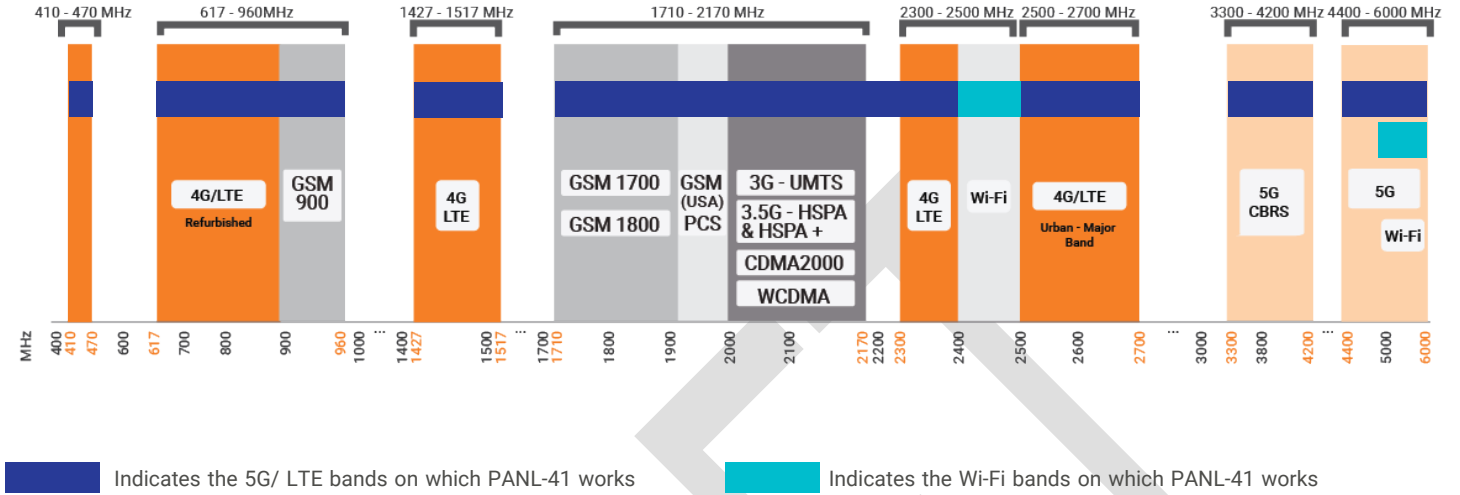

Antenna Overview

	5G LTE	GPS
Number of Ports	4	1
SISO / MIMO	4x4 MIMO	SISO
Frequency Bands	410 – 6000 MHz	L1: 1575.42 MHz ± 20 MHz L5: 1176.45 MHz ± 20 MHz
Polarisation	Linear Vertical & Horizontal	RHCP
Peak Gain	10.5 dBi	28±3 dB (LNA Gain)
Coax Cable Type	RTK-031	RTK-031
Coax Cable Length	2m	2m
Connector Type	SMA (M)	SMA (M)

Electrical Specifications – Cellular

Frequency Bands:	410 – 470 MHz 617 – 960 MHz 1427 -1517 MHz 1710 -2700 MHz 3300 – 4200 MHz 4400 – 6000 MHz
Gain (Max):	-3dBi @ 410 – 470 MHz 2 dBi @ 617 – 960 MHz 3 dBi @ 1427 – 1517 MHz 6.2 dBi @ 1710 – 2700 MHz 7.5 dBi @ 3400 - 4200 MHz 10.5 dBi @ 5000 - 6000 MHz
VSWR:	≤2:1 across 85% of the band
Feed Power Handling:	10 W
Input Impedance:	50 Ohm (nominal)
Polarisation:	Linear Vertical & Horizontal
Coax Cable Loss:	0.39 dB/m @ 400 MHz 0.54 dB/m @ 900 MHz 0.68 dB/m @ 1500 MHz 0.79 dB/m @ 1800 MHz 1.09 dB/m @ 3000 MHz 1.65 dB/m @ 5800 MHz
DC Short:	Yes

Electrical Specifications – GPS / GNSS

Frequency Range:	1575.42 MHz 1176.45MHz
LNA Gain:	28±3 dB
VSWR:	<2:1
DC Voltage:	3.3-5 V
Operating Current:	<20mA
Noise Figure:	≤1.5 dB
Nominal Impedance:	50 Ω
Polarisation:	RHCP
Out of Band Rejection:	1575 MHz ± 25 MHz: 30dBc min 1176 MHz ± 20 MHz: 30dBc min
Coax Cable Loss:	0.68 db/m @ 1500 MHz

Product Box Contents

Antenna:	A-PANL-0041-V1-01
Mounting Bracket:	Adhesive Mount and Suction Cups

Ordering Information

Commercial Name:	PANL-41
Order Product Code:	A-PANL-0041-V1-01
EAN Number:	6009710928493

Mechanical Specifications

Product Dimensions:	267 mm x 217 mm x 31 mm
Packaged Dimensions:	TBC
Weight:	TBC
Packaged Weight:	TBC
Radome Material:	UV Stable ASA
Radome Colour:	Black
Mounting Type:	Adhesive Mount and Suction Mount

Environmental Specifications, Certification & Approvals

Wind Survival:	≤160km/h
Temperature Range (Operating):	-40°C to +80°C
Environmental Conditions:	Indoor
Water Ingress Protection Ratio/Standard:	IP 65
Salt Spray:	MIL-STD 810G/ASTM B117
Operating Relative Humidity:	Up to 98%
Storage Humidity:	5% to 95% - non-condensing
Storage Temperature:	-40°C to +70°C
Enclosure Flammability Rating:	UL 94-HB
Impact Resistance:	IK 08
Product Safety & Environmental:	Complies with CE and RoHS standards

Antenna Performance Plots

VSWR

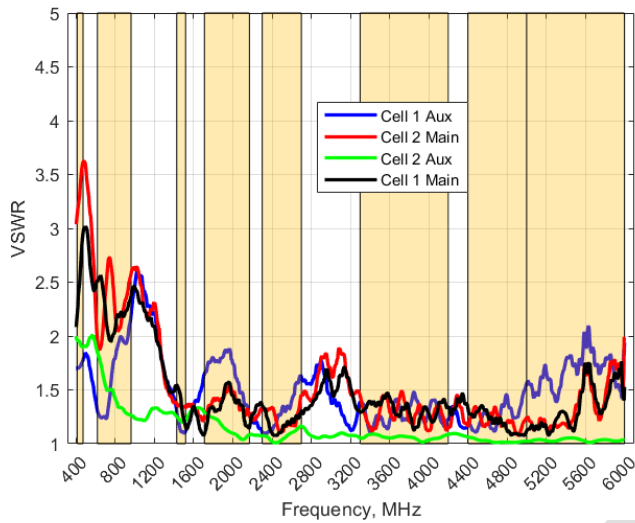

GAIN (EXCLUDING CABLE LOSS)

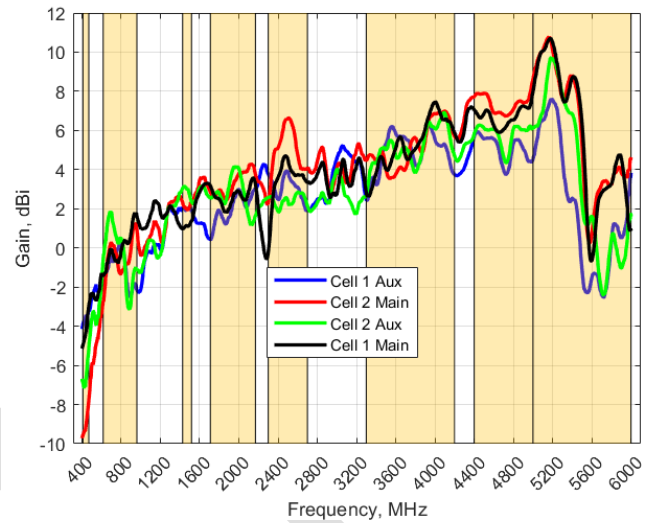

Voltage Standing Wave Ratio (VSWR)*

VSWR is a measure of how efficiently radio-frequency power is transmitted from a power source, through a transmission line, into a load. In an ideal system, 100% of the energy is transmitted which corresponds to a VSWR of 1:1.

The PANL-61 delivers superior performance across all bands with a VSWR of $\leq 2:1$, across 85% of the bands of interest.

Gain+ in dBi

10.5 dBi is the peak gain across all bands from 410 – 6000 MHz

Gain @ 410 – 470 MHz:	-3 dBi
Gain @ 617 – 960 MHz:	2 dBi
Gain @ 1427 – 1517 MHz:	3 dBi
Gain @ 1710 – 2700 MHz:	6.2 dBi
Gain @ 3300 – 4200 MHz:	7.5 dBi
Gain @ 4400 – 6000 MHz:	10.5 dBi

*VSWR measured with 2m low loss cable.

*Antenna gain measured with polarisation aligned standard antenna

ISOLATION

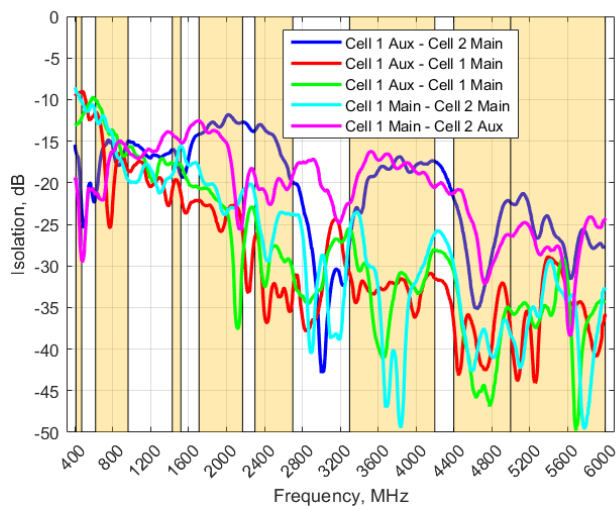

Isolation

Isolation is a measure of how much energy from one port leaks into another port undesirably. Isolation of 0 dB between 2 ports means that there is no isolation and the energy from 1 port excitation is visible on another port. Isolation of -30 dB or more means that <0.1% of 1 port's energy is leaked into another. A good isolation is under -10 dB.

Radiation Patterns - Cellular

Azimuth: 410 - 470 MHz

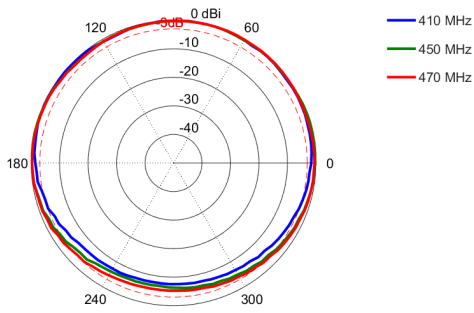

Elevation: 410 - 470 MHz

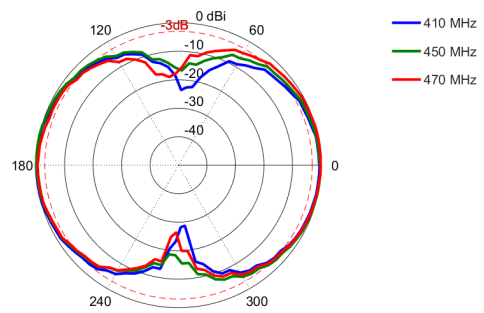

Azimuth: 617 - 960 MHz

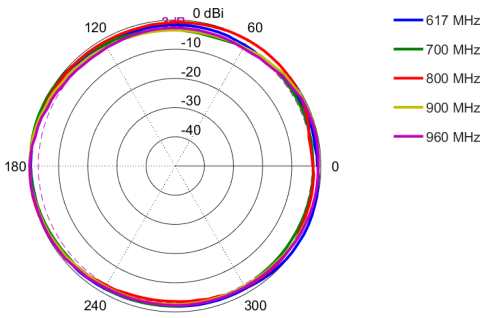

Elevation: 617 - 960 MHz

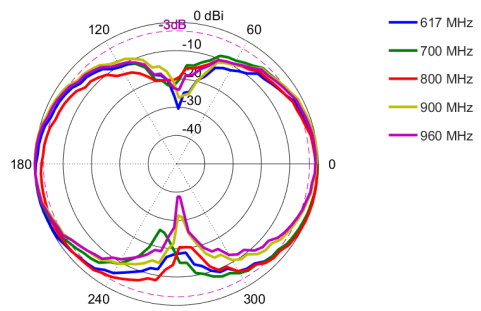

Azimuth: 1427 - 1517 MHz

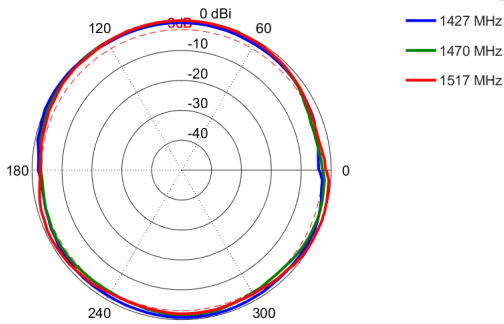

Elevation: 1427 - 1517 MHz

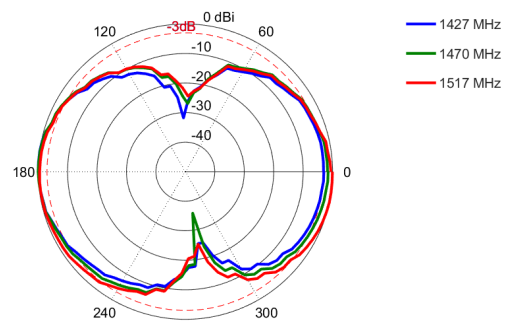

Azimuth: 1710 - 2170 MHz

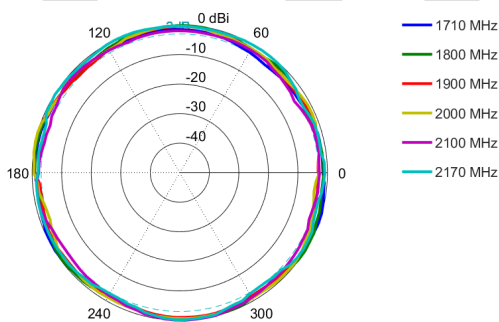

Elevation: 1710 - 2170 MHz

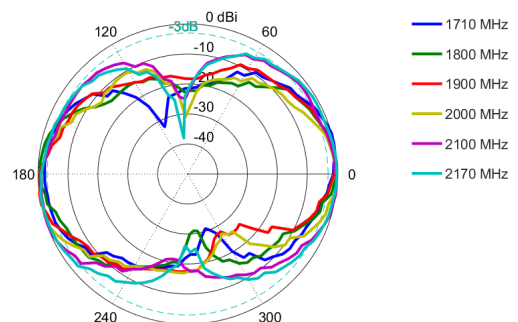

Azimuth: 2300 – 2700 MHz

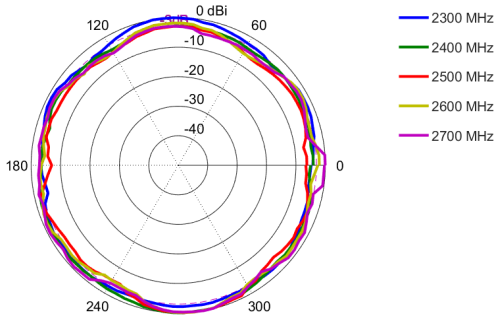

Elevation: 2300 – 2700 MHz

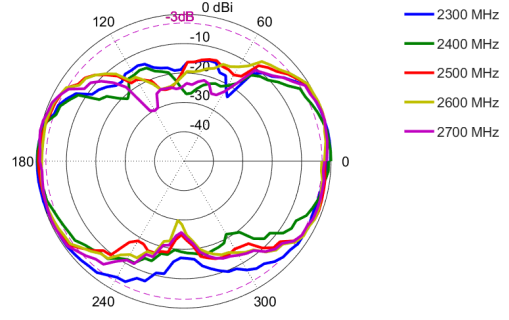

Azimuth: 3300 – 3800 MHz

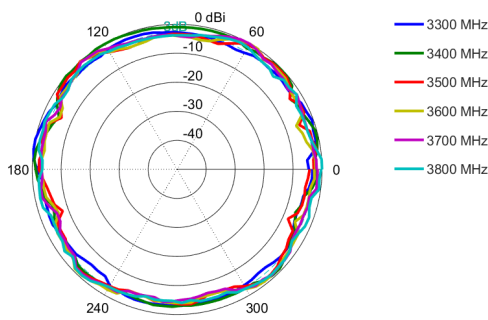

Elevation: 3300 – 3800 MHz

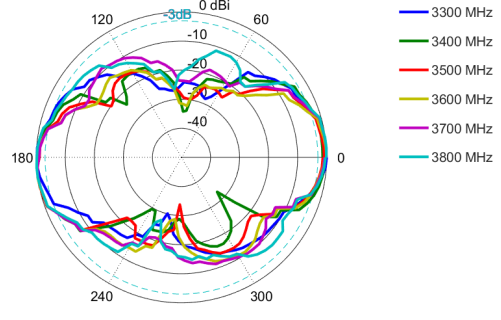

Azimuth: 3900 – 4200 MHz

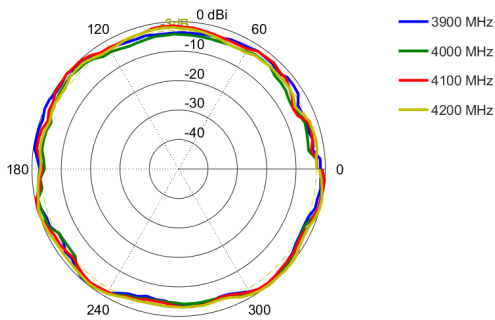

Elevation: 3900 – 4200 MHz

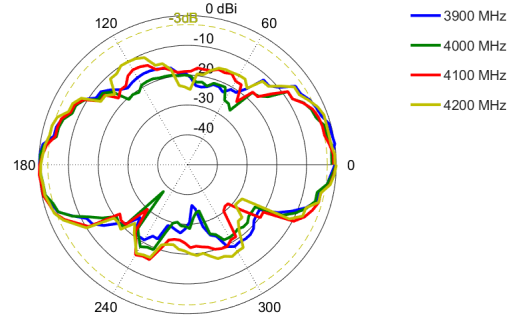

Azimuth: 4400 – 5000 MHz

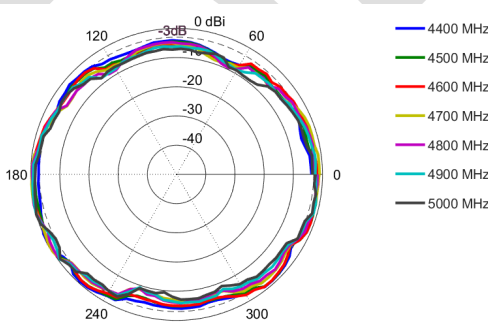

Elevation: 4400 – 5000 MHz

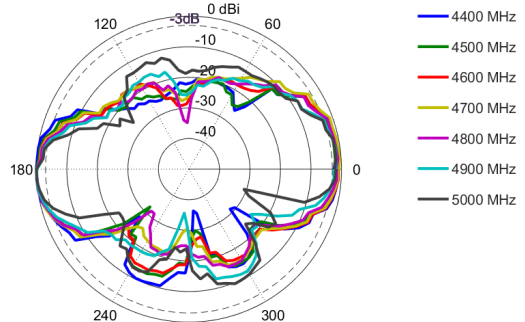

Technical Drawings

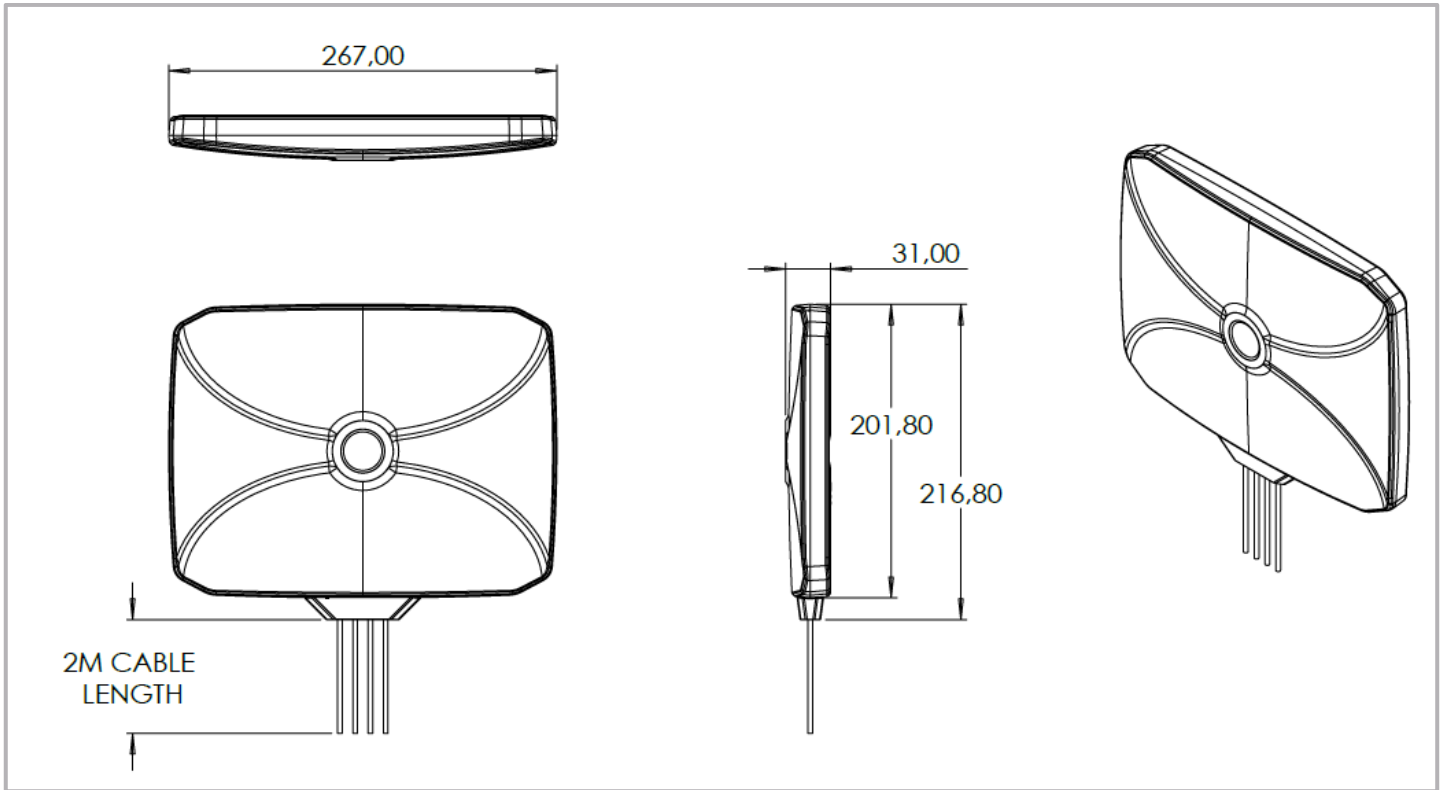

DRAFT

Additional Accessories

See accessories technical specifications on www.poynting.tech



CONTACT POYNTING

Poynting Antennas (Pty) Ltd - Head Office

Unit 4, N1 Industrial Park,
Landmarks Avenue,
Samrand, 0157, South Africa

Phone: +27 (0) 12 657 0050

E-mail: info@poynting.tech

International Email: sales-global@poynting.tech

Poynting Europe

Regus Business Center Neue Messe Riem
Kronstadter Straße 4
81677 München
Germany

Phone: +49 89 7453 9002

E-mail: sales-europe@poynting.tech

Poynting USA

1804 Owen Court, Suite 104,
Mansfield,
TX 76063
USA

Phone: +1 817 533-8130

E-mail: sales-us@poynting.tech