

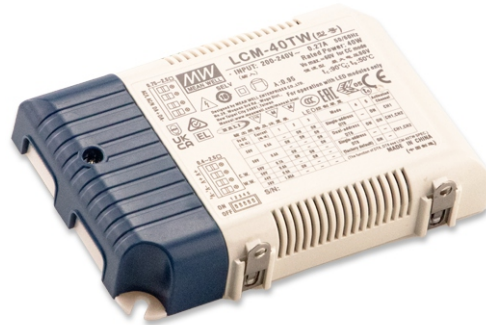

40W Constant Power Mode With Tunable White LED Driver

LCM-40TW series



DC Input: 180-260Vdc
AC Input: 200-240Vac

■ Features

- DALI device type 6(DT6) and device type 8(DT8) available
- Constant power mode output with 2 channels
- Plastic housing with class II and PFC design
- Flick free, complying with IEEE1789
- Standby power consumption <0.5W
- Minimum dimming level 0.2%
- Cooling by free air convection
- Emergency lighting (EL) available
- 5 years warranty

■ Applications

- Tunable White Lighting
- Human Centric Lighting(HCL)
- Downlight
- Panel Light
- Decorative Light
- Commercial Lighting
- DALI digital Lighting

■ GTIN CODE

MW Search: <https://www.meanwell.com/serviceGTIN.aspx>

■ Description

LCM-40TW Series is a 40W constant power output LED driver with two channels output for Tunable white function. It can operate from 180~277V AC and output current ranging between 500 mA to 1050 mA selectable by dip switch. Thanks to high efficiency up to 87%, it is able to operate for -30°C~85°C case temperature under free air convection. LCM-40TW is designed based on DALI-2 DT8 Tunable white and is also usable as two independent output channels with DT6 function. LCM-40TW can be adjusted for light intensity and color temperature by a push button as a simple way dimming, so it provides the design flexibility for LED Lighting application.

■ Model Encoding

LCM - 40 TW

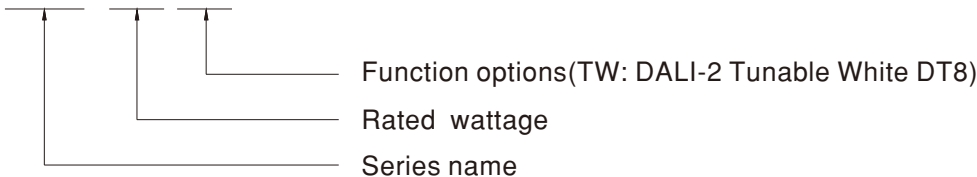



SPECIFICATION

MODEL		LCM-40TW	
OUTPUT	OUTPUT CHANNEL	CH1	CH2
	DC VOLTAGE RANGE	20~50V	20~50V
	NO LOAD VOLTAGE	53V	53V
	DEFAULT CURRENT	700mA	700mA
	CURRENT ADJ. RANGE (BY DIP SWITCH)	500~1050mA	500~1050mA
	RATED POWER	40W Max. total	
	CURRENT RIPPLE <small>Note5</small>	<2%	
	DIMMING RANGE	0~100%	
	START UP TIME <small>Note9</small>	500ms/230VAC	
INPUT	VOLTAGE RANGE	180~277VAC	260~390VDC
	FREQUENCY RANGE	47 ~ 63Hz	
	POWER FACTOR	PF≥0.98/230VAC, PF≥0.95/277VAC@full load (Please refer to "POWER FACTOR (PF) CHARACTERISTIC" section)	
	TOTAL HARMONIC DISTORTION	THD < 10% (@load 50%/230VAC; @load 75%/277VAC) (Please refer to "TOTAL HARMONIC DISTORTION(THD)" section)	
	EFFICIENCY(Typ.) <small>Note4</small>	87%	
	AC CURRENT	0.23A/230VAC	
	INRUSH CURRENT	COLD START 20A(twidth=310μs measured at 50% Ipeak) at 230VAC; Per NEMA 410	
	LEAKAGE CURRENT	<0.75mA / 277VAC	
	STANDBY POWER CONSUMPTION <small>Note6</small>	standby power consumption<0.5W (Dimming off)	
PROTECTION	OVERLOAD	105~135% rated output power Protection type: Hiccup mode, recovers automatically after fault condition is removed.	
	SHORT CIRCUIT	Constant current limiting, recovers automatically after fault condition is removed	
	OVER TEMPERATURE	Stage 1: Derating to 70% loading; stage2: Shut down. Recovers automatically after fault condition is removed	
ENVIRONMENT	WORKING TEMP.	Tcase=-30~85℃ (Please refer to "OUTPUT LOAD vs TEMPERATURE" section)	
	MAX. CASE TEMP.	Tcase=85℃	
	WORKING HUMIDITY	20 ~ 90% RH non-condensing	
	STORAGE TEMP., HUMIDITY	-40 ~ +80℃, 10 ~ 95% RH	
	TEMP. COEFFICIENT	±0.03%/℃ (0 ~ 50℃)	
	VIBRATION	10 ~ 500Hz, 2G 10min./1cycle, period for 60min. each along X, Y, Z axes	
	OPERATING ALTITUDE	2000 meters	
SAFETY&EMC	SAFETY STANDARDS	ENEC BS EN/EN61347-1, BS EN/EN61347-2-13(EL) appendix J suitable for emergency installations(DC Input: 180-260Vdc, AC Input: 200-240Vac); BS EN/EN62384 independent, GB19510.14, GB19510.1, EAC TP TC 004 approved;	
	DALI STANDARDS	Comply with IEC62386-101, 102, 207(DT6),209(DT8),251	
	WITHSTAND VOLTAGE	I/P-O/P:3.75KVAC	
	ISOLATION RESISTANCE	I/P-O/P:>100M Ohms / 500VDC / 25℃/ 70% RH	
	EMC EMISSION	Compliance to BS EN/EN55015, BS EN/EN61000-3-2 Class C(@load 50%) ; BS EN/EN61000-3-3; GB/T 17743, GB17625.1, EAC TP TC 020	
	EMC IMMUNITY	Compliance to BS EN/EN61000-4-2,3,4,5,6,8,11, BS EN/EN61547, light industry level(surge immunity Line-Line 2KV), EAC TP TC 020	
OTHERS	MTBF	2111.7K hrs min. Telcordia SR-332 (Bellcore)	177.4Khrs min. MIL-HDBK-217F (25℃)
	DIMENSION	123.5*81.5*23mm (L*W*H)	
	PACKING	0.24Kg ; 54pcs/15Kg/1.12CUFT	
NOTE	<ol style="list-style-type: none"> All parameters NOT specially mentioned are measured at 230VAC input, rated current and 25℃ of ambient temperature. De-rating may be needed under low input voltages. Please refer to "STATIC CHARACTERISTIC" sections for details. Length of set up time is measured at first cold start. Turning ON/OFF the driver may lead to increase of the set up time. Efficiency is measured at 800mA/50V output set by DIP switch. Current ripple is measured 50%~100% of maximum voltage under rated power delivery. Standby power consumption is measured at 180-230VAC. The driver is considered as a component that will be operated in combination with final equipment. Since EMC performance will be affected by the complete installation, the final equipment manufacturers must re-qualify EMC Directive on the complete installation again. (as available on https://www.meanwell.com/Upload/PDF/EMI_statement_en.pdf) The ambient temperature derating of 3.5℃/1000m with fanless models and of 5℃/1000m with fan models for operating altitude higher than 2000m(6500ft). Based on IEC 62386-101/102 DALI power on timing and interruption regulations, the set up time needs to test with a DALI controller which can support for DALI power on function, otherwise the start up time will be higher than 0.5 second. For more information, please contact with MEAN WELL sales. <p>※ Product Liability Disclaimer : For detailed information, please refer to https://www.meanwell.com/serviceDisclaimer.aspx</p>		

■ BLOCK DIAGRAM

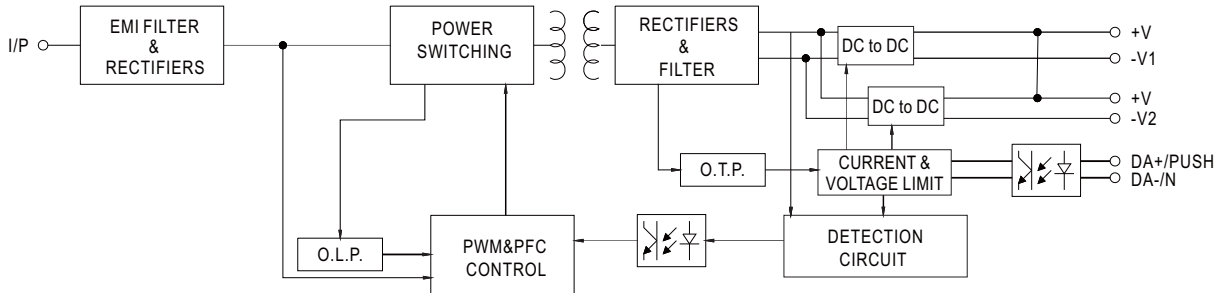

■ DRIVING METHODS OF LED MODULE

※ I-V Operating Area

◎ LCM-40TW

For 40W application

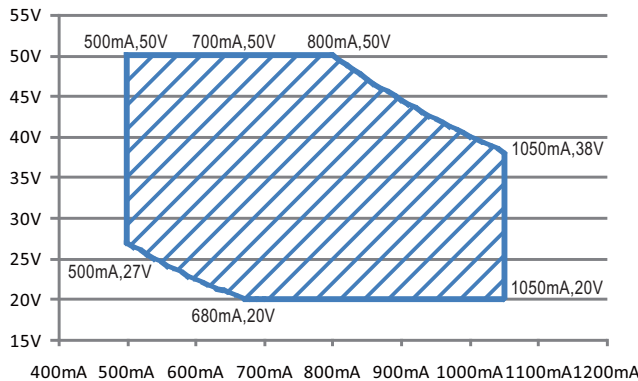

■ DIP SWITCH TABLE

LCM-40TW is a multiple-stage constant power driver, selection of output current through DIP switch is exhibited below.

Vo	Io	DIP S.W		
		1	2	3
27~50V	500mA	----	ON	ON
		ON	ON	ON
25~50V	600mA	----	----	ON
		ON	----	ON
20~50V	700mA(factory default)	ON	ON	----
20~50V	800mA	----	ON	----
20~44V	900mA	ON	----	----
20~38V	1050mA	----	----	----

Status	DIP S.W		Activated Channel
	4	5	
Single-address DT6	----	ON	CH1
Dual-address DT6	ON	ON	CH1,CH2
Single-address DT8 (factory default)	----	----	CH1,CH2
	ON	----	

Note: 1. For more current setting, please contact MW's sales.
2. The operating voltage range which show on this table is recommend to use.

■ DIMMING OPERATION

※ Output wiring diagram

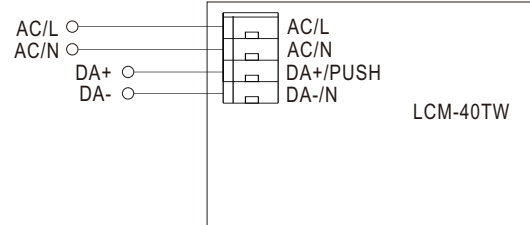
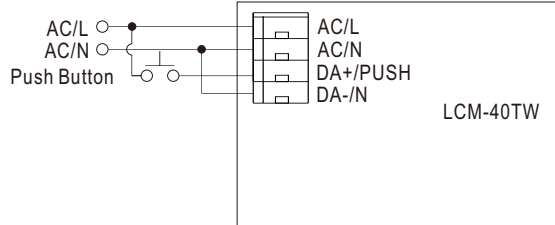

※ PUSH dimming (primary side)

- The factory default dimming level is at 100%.
- If the push action lasts less than 0.05 sec., it will not lead to a change for the status of the driver.
- Up to 10 drivers can perform the PUSH dimming at the same time when utilizing one common push button.
- The maximum length of the cable from the push button to the last driver is 20 meters.

Action	Action duration
Short Push	0.1~1s
Double Click	Click twice in 1.5s
Long Push	1.5~10s

PUSH dimming functions table

Status	Output	Push button function
DT6 (Single Address)	CH1	Short Push : ON/OFF Double Click : go to maximum. Long Push : Dim up/down. - dim up stop at maximum; dim down stop at min dim (not dim off) - with next push, direction change (up/down) - dim up possible even if when unit is in standby mode (dim off mode)
DT6 (Dual Address)	CH1,CH2	Short Push: ON/OFF Double Click : go to maximum. Long Push : Dim up+CCT cooler/Dim down+CCT warmer - dim up stop at maximum; dim down stop at min dim (not dim off) - with next push, direction change (up/down) - dim up possible even if when unit is in standby mode (dim off mode)
DT8 (Single Address)	CH1(C.W.), CH2(W.W.)	Short Push : ON/OFF Double Click : Switch between Dim control or CCT control mode Long Push : Dim up/down or CCT control - dim up stop at maximum; dim down stop at min dim (not dim off) - with next push, direction change (up/down, warm/cold) - dim up possible even if when unit is in standby mode (dim off mode)

DIMMING CURVE

Dimming characteristics

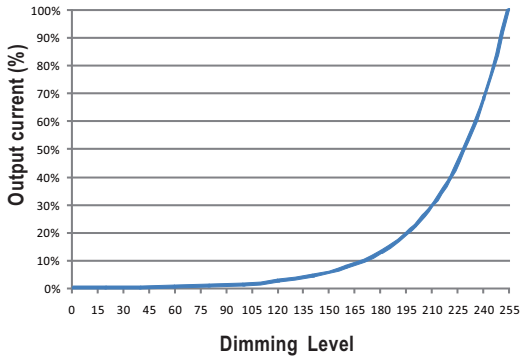

Dynamic range in colour temperature control

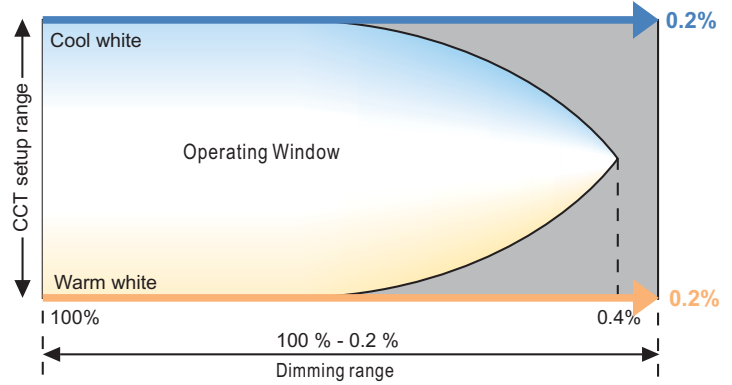

OUTPUT CONNECTIONS

Application	Output channels	Output connections schematic diagram
One channel output control(DT6)	Single address	
Two channels output control(DT6)	Dual address	
Tunable white control(DT8)	Single address	

OUTPUT LOAD vs TEMPERATURE

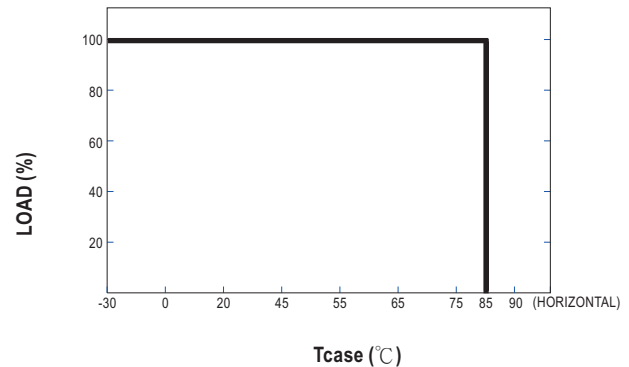
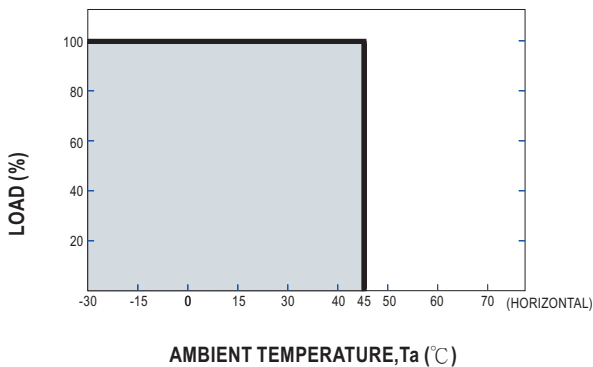

STATIC CHARACTERISTIC

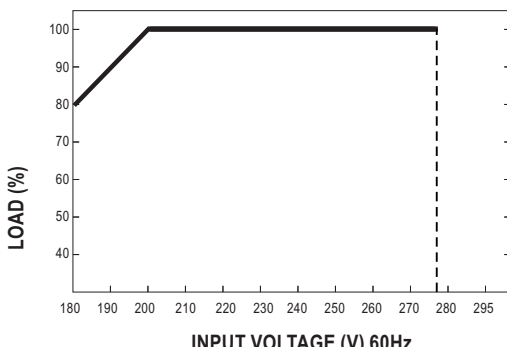

※ De-rating is needed under low input voltage.

TOTAL HARMONIC DISTORTION (THD)

※ Tcase at 85°C

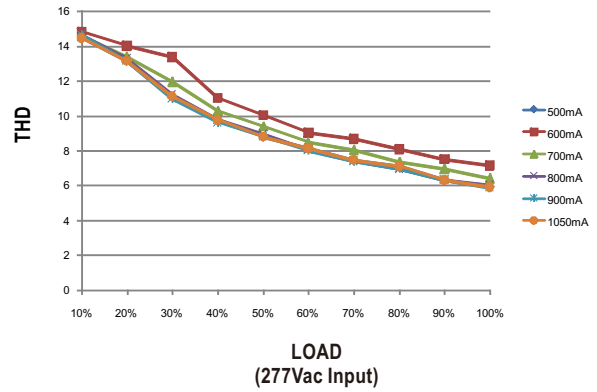
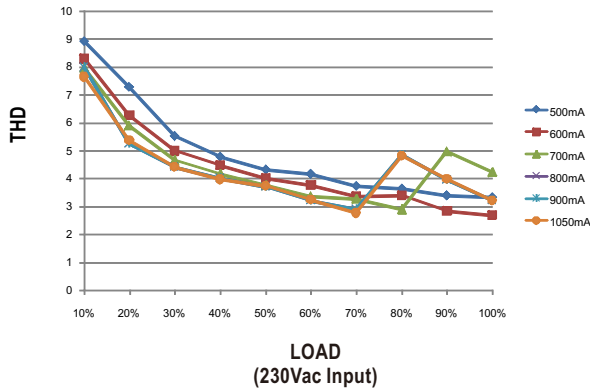

POWER FACTOR (PF) CHARACTERISTIC

※ Tcase at 85°C

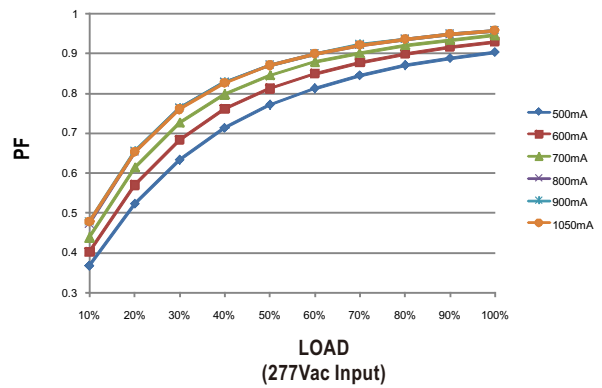
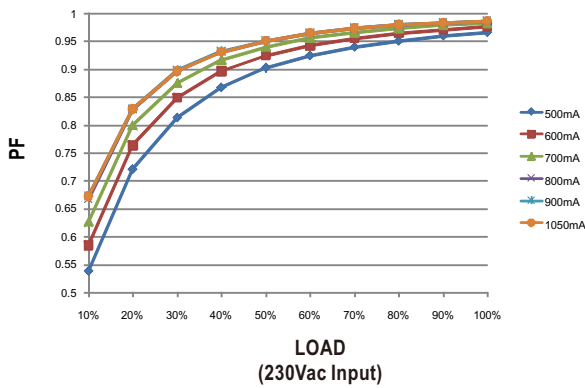

EFFICIENCY vs LOAD

LCM-40TW series possess superior working efficiency that up to 87% can be reached in field applications.

※ Tcase at 85°C

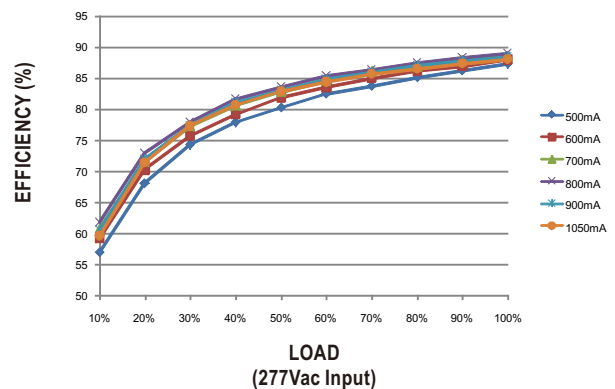
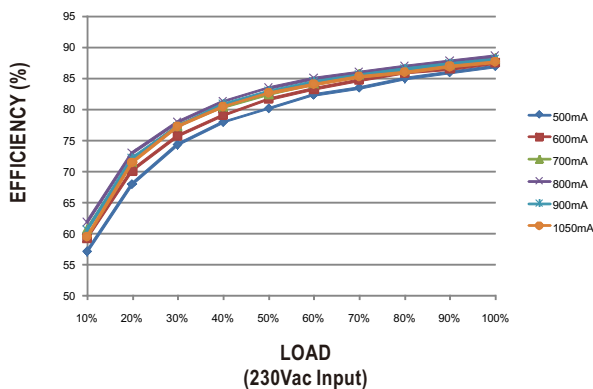

MECHANICAL SPECIFICATION

Case No.LCM-60A Unit:mm

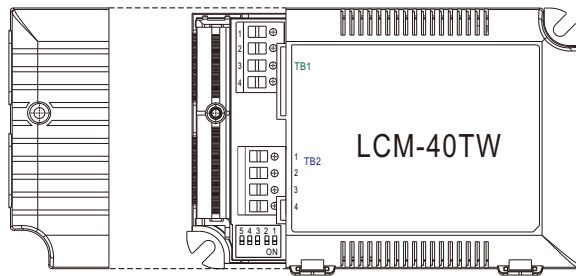
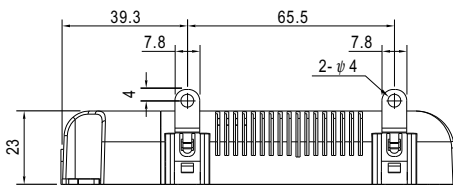
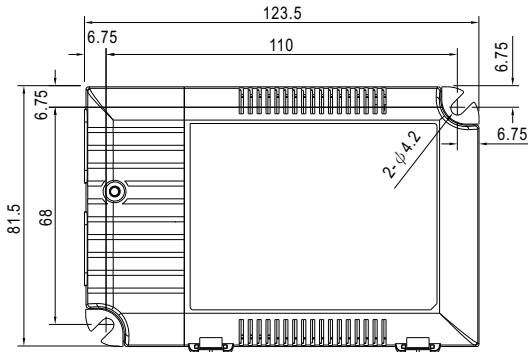

※ Terminal Pin No. Assignment(TB1)

Pin No.	Assignment
1	AC/L
2	AC/N
3	DA+/PUSH
4	DA-/N

※ Terminal Pin No. Assignment(TB2)

Pin No.	Assignment
1	+V
2	+V
3	-V1(C.W.)
4	-V2(W.W.)

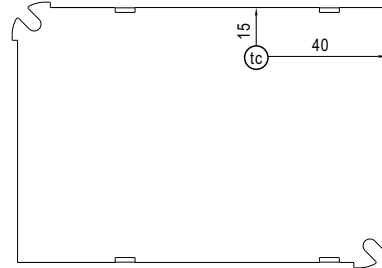

Bottom View

• (tc) : Max. Case Temperature

Installation Manual

Please refer to : <http://www.meanwell.com/manual.html>