

ITEM NO	COLOUR
S216322	pure white, RAL9010
S216323	pearl white, RAL1013

**Materials:**

Outlet Housing: ABS /UL94V2  
 Outlet Base: ABS /UL94V2  
 Metallic Plate: Al&Zn Alloy /Al&Zn Alloy,  
 PACKING: 1pcs/PE bag+label 1, 12pcs/box+label 2, 120pcs/ctn+label 1  
 RoHS 2.0 And REACH Compliant

SYNERGY 21										
CUSTOMER		ITEM NO.		See The Chart						
		UPDATE PACKING TYPE	2018-03-20	A1	PRODUCT NAME	Face plate 1 port	manufacture country	China	UNIT	MM
		NEW	2016-10-11	A	DRAWNBY	CHECKBY	APPOBY	DATE		
BY	CHK	REVISION RECORD MODIFICATIONS	DATE	REV.	SYNERGY 21	SYNERGY 21	SYNERGY 21	2018-03-20		

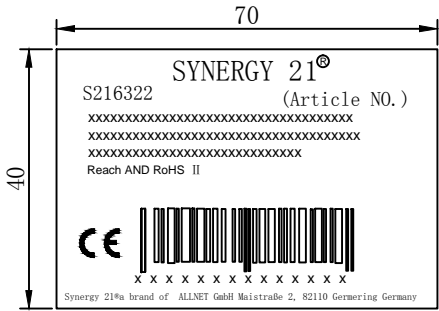

Label 1

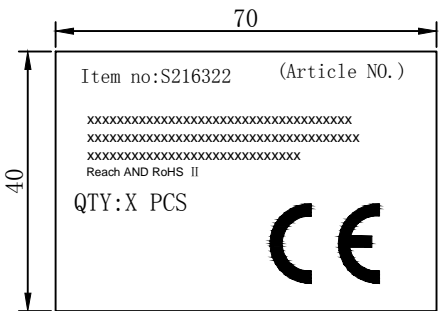

label 2

SHIPPING MARK



PO NO. :  
REACH and ROHS 2.0 Compliant  
MADE IN CHINA

SIDE MARK

PO NO. :  
Item no:  
Q' TY:  
N. W  
G. W  
Carton no.  
MEAS.

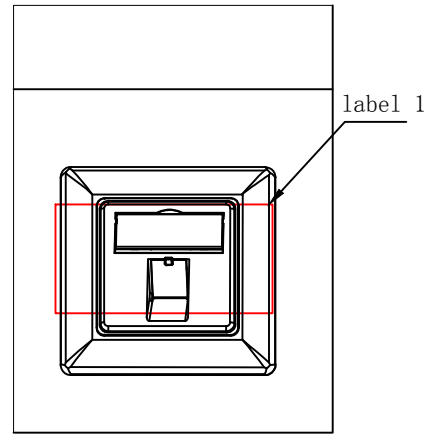

1PCS/PE bag+label1

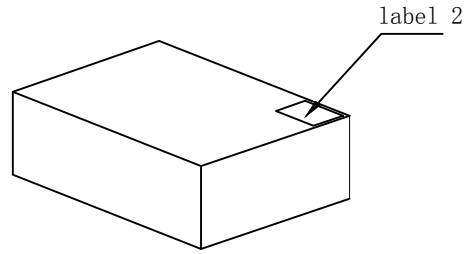
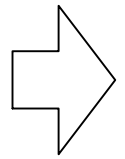

12pcs/box+label2

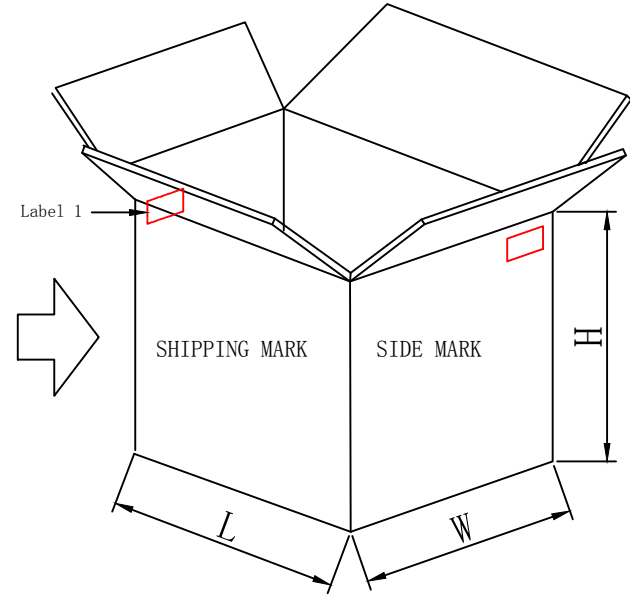
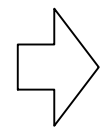

120pcs/ctn+label 1

- NOTE:
- 1.pcs/PE bag+label 1, 12pcs/box+label 2, 120pcs/ctn+label 1
  - “工” type sealing
  - “井” type packaging

SYNERGY 21									
CUSTOMER						ITEM NO.		See The Chart	
PRODUCT NAME		PACKING	manufacture country:		china	UNIT	MM		
DRAWNBY			CHECKBY			APPOBY		DATE	
SYNERGY 21		SYNERGY 21		SYNERGY 21		2018-03-20			

UPDATE PACKING TYPE			2018-03-20	A1
NEW			2014-09-25	A
BY	CHK	REVISION RECORD MODIFICATIONS	DATE	REV.