

ITEM NO	COLOUR
S216322	pure white, RAL9010
S216323	pearl white, RAL1013

Materials:

Outlet Housing: ABS /UL94V2
 Outlet Base: ABS /UL94V2
 Metallic Plate: Al&Zn Alloy /Al&Zn Alloy,
 PACKING: 1pcs/PE bag+label 1, 12pcs/box+label 2, 120pcs/ctn+label 1
 RoHS 2.0 And REACH Compliant

SYNERGY 21										
CUSTOMER		ITEM NO.		See The Chart						
		UPDATE PACKING TYPE	2018-03-20	A1	PRODUCT NAME	Face plate 1 port	manufacture country	China	UNIT	MM
		NEW	2016-10-11	A	DRAWNBY	CHECKBY	APPOBY	DATE		
BY	CHK	REVISION RECORD MODIFICATIONS	DATE	REV.	SYNERGY 21	SYNERGY 21	SYNERGY 21	2018-03-20		

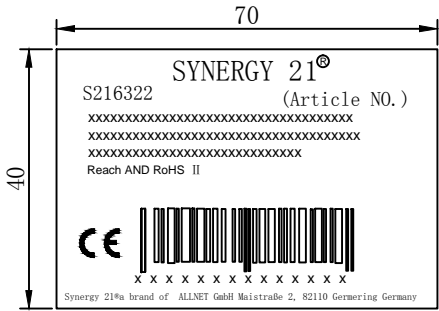

Label 1

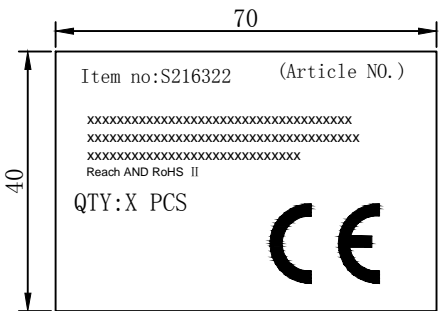

label 2

SHIPPING MARK



PO NO. :
REACH and ROHS 2.0 Compliant
MADE IN CHINA

SIDE MARK

PO NO. :
Item no:
Q' TY:
N. W
G. W
Carton no.
MEAS.

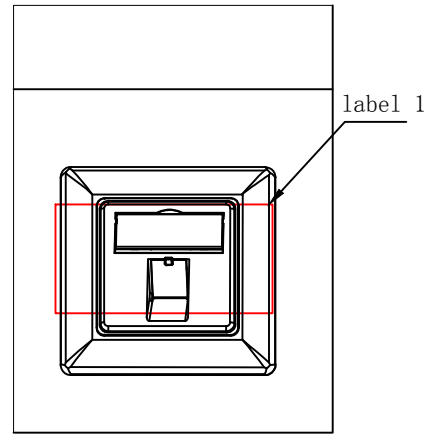

1PCS/PE bag+lable1

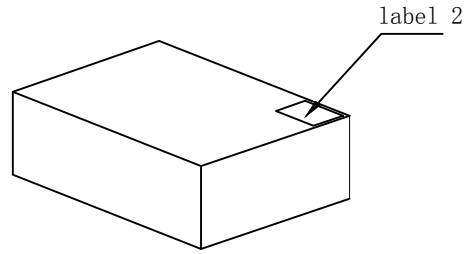
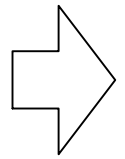

12pcs/box+lable2

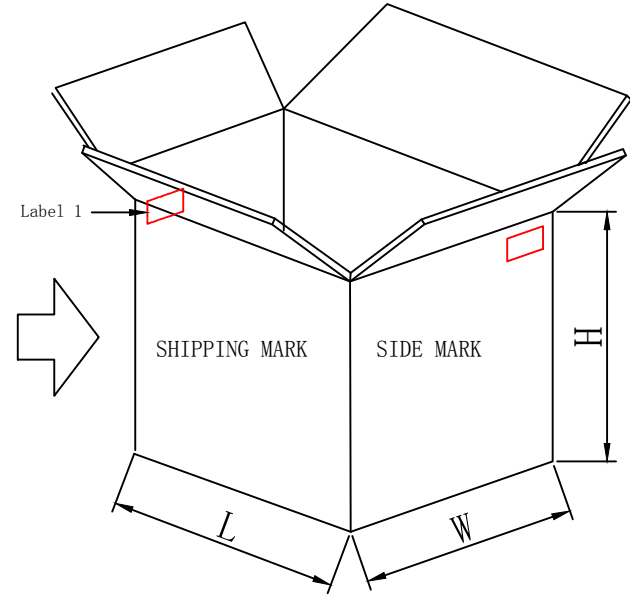
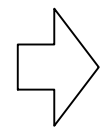

120pcs/ctn+lable 1

- NOTE:
- 1.pcs/PE bag+label 1, 12pcs/box+label 2, 120pcs/ctn+label 1
 - “工” type sealing
 - “井” type packaging

SYNERGY 21										
CUSTOMER						ITEM NO.		See The Chart		
PRODUCT NAME		PACKING	manufacture country:		china	UNIT	MM			
DRAWNBY			CHECKBY			APPOBY		DATE		
BY	CHK	REVISION RECORD MODIFICATIONS			DATE	REV.	SYNERGY 21	SYNERGY 21	SYNERGY 21	2018-03-20

		UPDATE PACKING TYPE			2018-03-20	A1
		NEW			2014-09-25	A

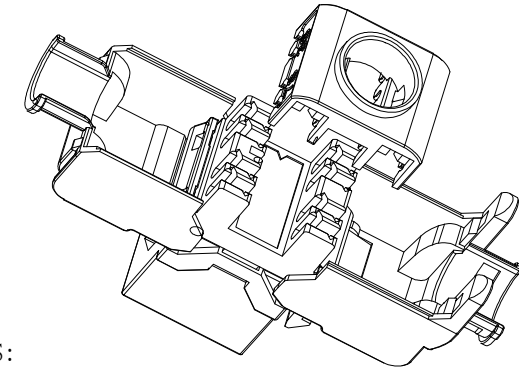
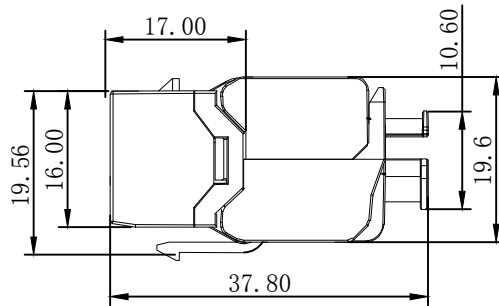
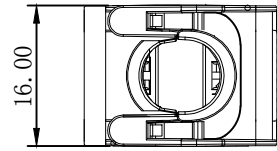
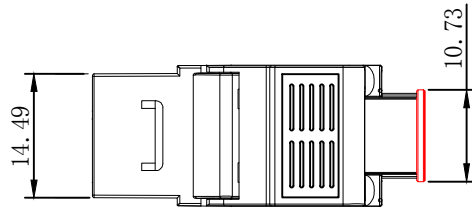
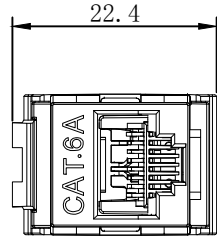

NOTES:

ELECTRICAL:

1. Contact Resistance : 20MΩ MAX
2. Insulation Resistance : 500MΩ MIN @ 500V DC
3. Withstand Voltage : DC 1000V AC 700V RMS 60Hz, 1MIN
4. Component testing for Cat.6A to ISO/IEC 11801 Ed. 2.2:2011-06
DIN EN 50173-1:2011-09
TIA/EIA-568-C.2 (2009-08)
IEC 60603-7-51 Ed.1 (12/2008)
5. Compliance with Class EA up to 500 MHz to ISO/IEC 11801 Ed.2.2:2011-06
DIN EN 50173-1:2011-09

ENVIRONMENTAL:

1. Storage : -40° TO+70°
2. Operation : -10° to+60°

MECHANICAL

1. SHIELD MATERIAL: ZINC ALLOY
2. IDC MATERIAL: PC UL94V0 TERMINAL:PHOSPHOR BRONZE, TIN PLATING
3. RJ45 Contact Life: 750 Times Min
4. Plug inforce:<30N
5. Solid cable:1/22AWG(0.65MM)-1/24AWG(0.45MM) ID:0.8MM-1.6MM
6. Stranded cable:7/22AWG(0.76MM)-7/26AWG(0.48MM) ID:0.8MM-1.6MM
7. Cable OD: 5.0mm-8.5mm
8. PoE per IEEE 802.3af, PoE+ per IEEE 802.3at
9. 360° Shield connection

Fluke Test:Permanent Link ISO 11801 (PL2)Class Ea
VOKA-LAN 1000MHz AWG23/1 CAT.7 Shielded 15M

RoHS 2.0 and REACH Compliant

MATERIAL LIST:

⑦	MODULAR COVER	FIREPROOF ABS UL94V0	1	
⑥	RJ 45 JACK INSERT	PHOSPHOR BRONZE 8P8C 6U"(0.15um) GOLD PLATED	8	
⑤	PCB	1.6mm UL 94V0	1	
④	IDC BODY	FIREPROOF/PC UL 94V0	1	
③	IDC PIN	PHOSPHOR BRONZE & TINNED	8	
②	LABEL COLOR CODE	T568A/B	2	
①	IDC TERMINAL	FOR 22-24AWG(0.45mm-0.65mm) CABLE	1	

NO	PARTS NAME	SPECIFICATION STANDARD	QT' Y	REMARK
Alvan	Alvan	Slightly modify the product appearance	2017-06-06	A1
		NEW	2016-02-24	A
BY	CHK	REVISION RECORD MODIFICATIONS	DATE	REV.

SYNERGY 21									
CUSTOMER			ITEM NO.	S216318					
PRODUCT NAME	CAT. 6A STP KEYSTONE JACK	manufacture country:	china	UNIT	MM				
DRAWNBY		CHECKBY	APPOBY		DATE				
SYNERGY 21		SYNERGY 21	SYNERGY 21	2017-06-06					

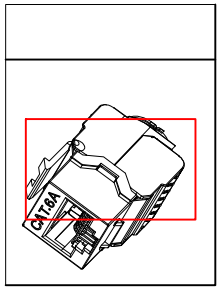

1PCS / PE BAG + label 1

Inner Carton: Single wall corrugated board

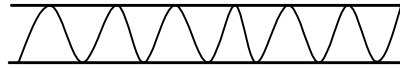

Carton: Double wall corrugated board

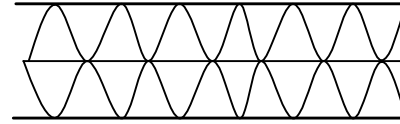

label 3

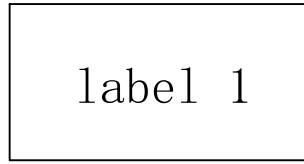

label 1

label 1 40*70mm

label 3 40*70mm

25pcs/Inner carton+label 2+user guides

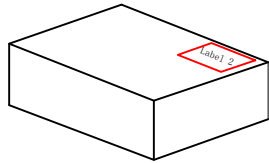

label 2



label 2

label 2 40*70mm

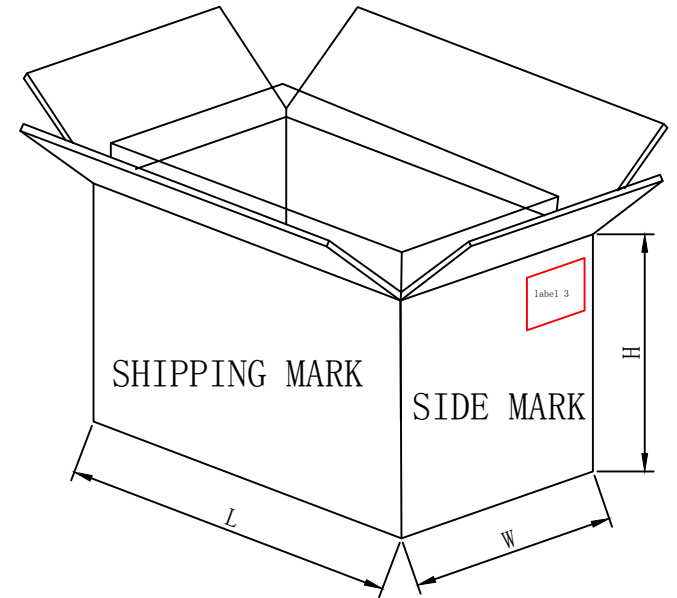
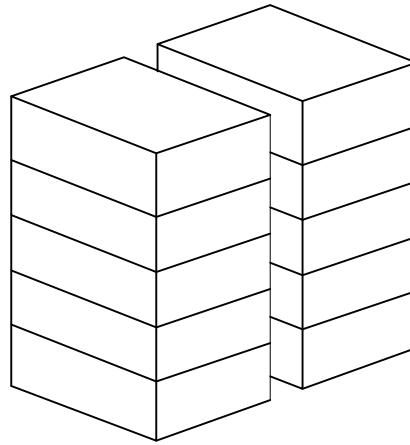

NOTE:

1. 1PCS/PE Bag+Label, 25pcs/Inner Carton + Label+user guides, 250pcs/ Carton with waterproof bag
2. “工” type sealing
3. “井” type packaging
4. See detailed specific requirements Packing

SYNERGY 21

						CUSTOMER				ITEM NO.		S216318					
						PRODUCT NAME		Packing		manufacture country:		china		UNIT		MM	
		NEW		2017-06-06		A		DRAWNBY		CHECKBY		APPOBY		DATE			
BY		CHK		REVISION RECORD MODIFICATIONS		DATE		REV.		Arvin		Alvan		2017-06-06			

Montageanweisung

Cat.6A UTP/STP Keystone jack

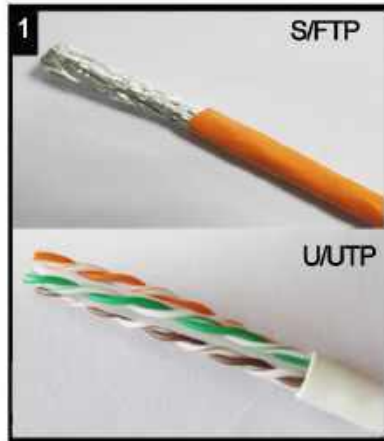

Außenmantel des Verlegekabels ca.4 cm abnehmen und Gesamtschirmung nach hinten ziehen.
Strip off approx. 4 cm of the cable jacket and fold total shield back over it.

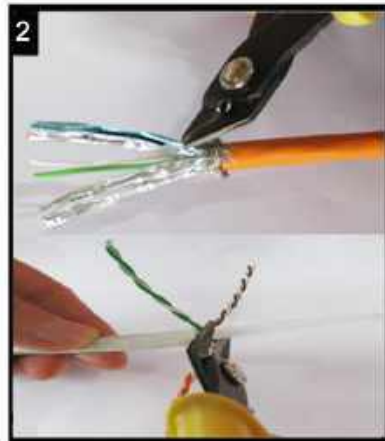

Paarfolie entfernen.
Remove pair shielding.



Der Kabelsortierer verfügt über beide Farbcodes(568A/B).Wählen Sie den entsprechenden Farbcode.
Please choose colour code 568A or B according your application.

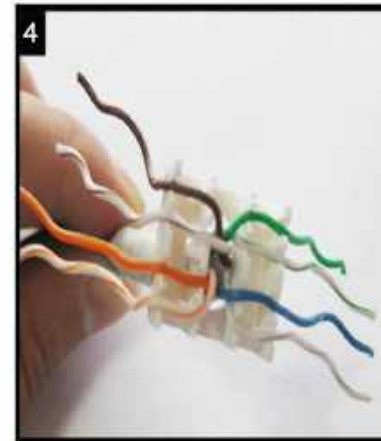

Kabel einführen und die einzelnen Adern nach der von Ihnen gewählten Belegungsvariante in den Kabelsortierer einführen.
Insert the cable into the termination cap and fan out all four twisted pairs following the colour code printed on the termination cap. Make sure that all conductors are in the proper slot.

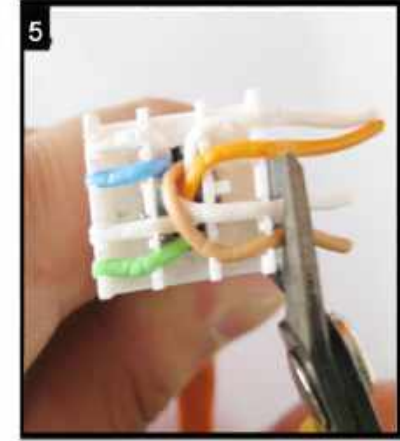

Überstehende Adern abschneiden.
Trim the ends of the conductors.

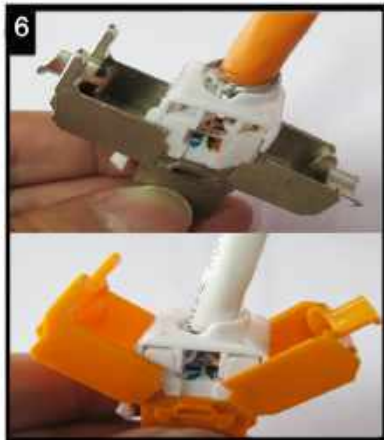

Den Sortierer in Pfeilrichtung in das Modul einsetzen.Bitte Pfeilrichtung beachten!
Install the termination cap in direction of arrow into the Keystone Jack.

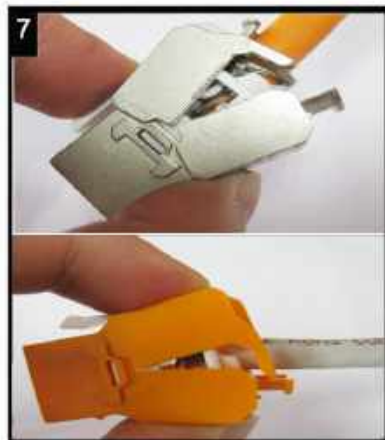

Die Montageklappen schließen -mit diesem Vorgang wird das Modul kontaktiert.
Press both covers of the Keystone Jack to contact the cable.

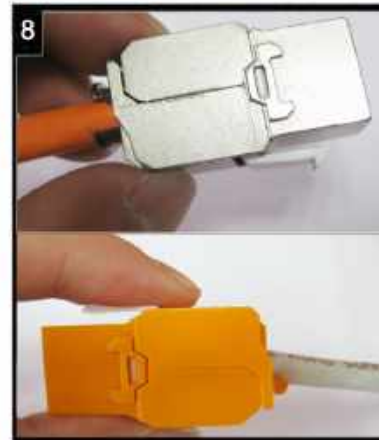

Ggf. die Anverterung nochmals kontrollieren und schließen.
Control the operation and close the Keystone Jack finally.

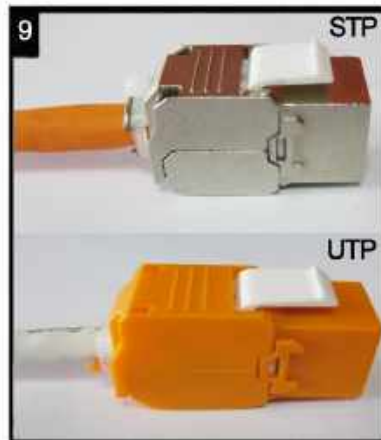

Das Modul mit dem Kabelbinder zugentasten und die Schirmschelle fixieren.
Use cable tie for strain relief and to fix the shielding clamp.

Oder mit kabel binder die zugentlastung zu fixieren.
Or cable tie to fix the strain relief.